

RESIDENTIAL GAS WATER HEATERS

NOT FOR USE IN MANUFACTURED (MOBILE) HOMES

INSTALLATION - OPERATION
- SERVICE - MAINTENANCE



Low Lead Content



WARNING: If the information in these instructions is not followed exactly, a fire or explosion may result causing property damage, personal injury or death.

- Do not store or use gasoline or other flammable vapors and liquids in the vicinity of this or any other appliance.
- **WHAT TO DO IF YOU SMELL GAS:**
 - Do not try to light any appliance.
 - Do not touch any electrical switch; do not use any phone in your building.
 - Immediately call your gas supplier from a neighbor's phone. Follow the gas supplier's instructions.
 - If you cannot reach your gas supplier, call the fire department.
- Installation and service must be performed by a qualified installer, service agency or the gas supplier.



WARNING

Read and understand this instruction manual and the safety messages herein before installing, operating or servicing this water heater.

Failure to follow these instructions and safety messages could result in death or serious injury.

This manual must remain with the water heater.

• **For Your Safety** •

AN ODORANT IS ADDED TO THE GAS USED BY THIS WATER HEATER.

PLACE THESE INSTRUCTIONS ADJACENT TO HEATER AND NOTIFY OWNER TO KEEP FOR FUTURE REFERENCE.

**KEEP THIS MANUAL IN THE POCKET ON HEATER FOR FUTURE REFERENCE
WHENEVER MAINTENANCE ADJUSTMENT OR SERVICE IS REQUIRED.**

TABLE OF CONTENTS





SAFE INSTALLATION, USE AND SERVICE.....	3	Outdoor Air Through Two Vertical Ducts.....	18
APPROVALS	3	Air From Other Indoor Spaces.....	18
GENERAL SAFETY INFORMATION.....	4	Venting.....	19
INTRODUCTION.....	5	Gas Piping.....	21
Abbreviations Used	5	Sediment Traps	22
Qualified Installer or Service Agency.....	5	TEMPERATURE REGULATION	24
Preparing for The Installation	5	Start-Up Conditions	25
TYPICAL INSTALLATION.....	6	FOR YOUR INFORMATION.....	25
GET TO KNOW YOUR WATER HEATER - GAS		Operational Conditions	26
MODELS	6	PERIODIC MAINTENANCE	27
Application/Use of Water Heater	7	Venting System Inspection	27
HOTTER WATER CAN SCALD.....	7	Burner Inspection	27
Facts to Consider About the Location.....	8	Burner Cleaning.....	27
High Altitude	9	Air Shutter Adjustment.....	28
Adjusting Air Shutter for Higher Altitudes.....	9	Housekeeping.....	28
Clearances	10	Anode Rod Inspection	28
Insulation Blankets	11	Temperature-Pressure Relief Valve Test	28
Hard Water	11	Draining and Flushing.....	30
INSTALLATION REQUIREMENTS	12	LEAKAGE TEST POINTS	31
Gas Supply Systems	12	Service.....	31
Gas Pressure Requirements	12	Removing and Replacing the Gas Control Valve/ Thermostat	32
Supply Gas Regulator	12		
Mixing Valves.....	13		
Water Piping	13		
Temperature-Pressure Relief Valve	14		
Filling the Water Heater	15		
Air Requirements.....	16		
Unconfined Space	16		
Confined Space	16		
Fresh Air Openings For Confined Spaces	17		
Outdoor Air Through Two Openings	17		
Outdoor Air Through One Opening.....	17		
Outdoor Air Through Two Horizontal Ducts	18		

SAFE INSTALLATION, USE AND SERVICE

The proper installation, use and servicing of this water heater is extremely important to your safety and the safety of others.

Many safety-related messages and instructions have been provided in this manual and on your own water heater to warn you and others of a potential injury hazard. Read and obey all safety messages and instructions throughout this manual. It is very important that the meaning of each safety message is understood by you and others who install, use, or service this water heater.

	<p>This is the safety alert symbol. It is used to alert you to potential personal injury hazards. Obey all safety messages that follow this symbol to avoid possible injury or death.</p>
---	---

	<p>DANGER indicates an imminently hazardous situation which, if not avoided, will result in injury or death.</p>
	<p>WARNING indicates a potentially hazardous situation which, if not avoided, could result in injury or death.</p>
	<p>CAUTION indicates a potentially hazardous situation which, if not avoided, could result in minor or moderate injury.</p>
	<p>CAUTION used without the safety alert symbol indicates a potentially hazardous situation which, if not avoided, could result in property damage.</p>

All safety messages will generally tell you about the type of hazard, what can happen if you do not follow the safety message, and how to avoid the risk of injury.

APPROVALS



GENERAL SAFETY INFORMATION



⚠ WARNING

Read and understand instruction manual and safety messages before installing, operating or servicing this water heater.

Failure to follow instructions and safety messages could result in death or serious injury.

Instruction manual must remain with water heater.



⚠ WARNING

Fire Hazard

For continued protection against risk of fire:

- Do not install water heater on carpeted floor.
- Do not operate water heater if flood damaged.

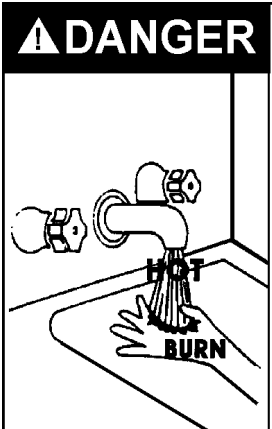

⚠ DANGER

Water temperature over 125°F (52°C) can cause severe burns instantly resulting in severe injury or death.

Children, the elderly, and the physically or mentally disabled are at highest risk for scald injury.

Feel water before bathing or showering.

Temperature limiting valves are available.

Read instruction manual for safe temperature setting.

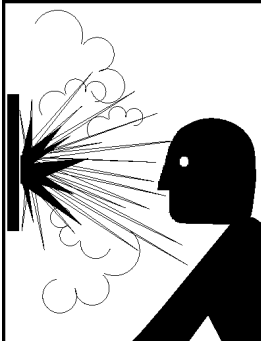

⚠ WARNING

Explosion Hazard

- Overheated water can cause water tank explosion.
- Properly sized temperature and pressure relief valve must be installed in opening provided.

⚠ WARNING

Fire or Explosion Hazard

- Avoid all ignition sources if you smell gas.
- Do not expose water heater control to excessive gas pressure.
- Use only gas shown on rating plate.
- Maintain required clearances to combustibles.
- Keep ignition sources away from faucets after extended period of non-use.

Read instruction manual before installing, using or servicing water heater.

⚠ WARNING

Breathing Hazard - Carbon Monoxide Gas

- Install vent system in accordance with codes.
- Do not operate water heater if flood damaged.
- High altitude office must be installed above 7,700 ft. (2,347 m).
- Do not operate if soot buildup.
- Do not obstruct water heater air intake with insulating jacket.
- Do not place chemical vapor emitting products near water heater.
- Gas and carbon monoxide detectors are available.

Breathing carbon monoxide can cause brain damage or death. Always read and understand instruction manual.

⚠ DANGER

Fire or Explosion Hazard

- Do not store or use gasoline or other flammable vapors and liquids in the vicinity of this or any other appliance.

FLAMMABLE

Flammable Vapors

PRECAUCIÓN

Una instalación, uso o servicio técnico inadecuados pueden generar daños a la propiedad.

- No haga funcionar el calentador de agua si alguna parte ha quedado expuesta a inundaciones o daños por el agua.
- Inspeccione las varillas del ánodo de manera regular y reemplácelas si están gastadas de manera significativa.
- Instale en un lugar con drenaje.
- Llene el tanque con agua antes de ponerlo en funcionamiento.
- Se necesitan tanques de expansión térmica correctamente dimensionados en todos los sistemas de agua.

Consulte este manual para la instalación y el mantenimiento.

INTRODUCTION

Thank You for purchasing this water heater. Properly installed and maintained, it should give you years of trouble free service.

ABBREVIATIONS USED

Abbreviations Found In This Instruction Manual:

- UL - Underwriters Laboratories Inc.
- ANSI - American National Standards Institute
- NFPA - National Fire Protection Association
- ASME - American Society of Mechanical Engineers
- AHRI - Air-Conditioning, Heating and Refrigeration Institute
- CAN - Canada
- EPACT - Energy Policy Act
- CSA - Canadian Standards Association

This gas-fired water heater is design certified by Underwriters Laboratories Inc. under the **American National Standard/CSA Standard for Gas Water Heaters ANSI Z21.10.3 • CSA 4.3** (current edition).

QUALIFIED INSTALLER OR SERVICE AGENCY

Installation and service of this water heater requires ability equivalent to that of a Qualified Agency (as defined by ANSI below) in the field involved. Installation skills such as plumbing, air supply, venting, gas supply and electrical supply are required in addition to electrical testing skills when performing service.

ANSI Z223.1 2006 Sec. 3.3.83: "Qualified Agency" - "Any individual, firm, corporation or company that either in person or through a representative is engaged in and is responsible for (a) the installation, testing or replacement of gas piping or (b) the connection, installation, testing, repair or servicing of appliances and equipment; that is experienced in such work; that is familiar with all precautions required; and that has complied with all the requirements of the authority having jurisdiction."

If you are not qualified (as defined by ANSI above) and licensed or certified as required by the authority having jurisdiction to perform a given task do not attempt to perform any of the procedures described in this manual. If you do not understand the instructions given in this manual do not attempt to perform any procedures outlined in this manual.

PREPARING FOR THE INSTALLATION

1. Read the "General Safety" section, page 4 of this manual first and then the entire manual carefully. If you don't follow the safety rules, the water heater will not operate properly. It could cause DEATH, SERIOUS BODILY INJURY AND/OR PROPERTY DAMAGE.

This manual contains instructions for the installation, operation, and maintenance of the gas-fired water heater. It also contains warnings throughout the manual that you must read and be aware of. All warnings and all instructions are essential to the proper operation of the water heater and your safety. Since we cannot put everything on the first few pages, READ THE ENTIRE MANUAL BEFORE ATTEMPTING TO INSTALL OR OPERATE THE WATER HEATER.

2. The installation must conform with these instructions and the local code authority having jurisdiction. In the absence of local codes, the installation must comply with the National Fire Protection Association, 1 Batterymarch Park, Quincy, MA 02269.

3. If after reading this manual you have any questions or do not understand any portion of the instructions, call the local gas utility or the manufacturer whose name appears on the rating plate.

4. Carefully plan the place where you are going to put the water heater. Correct combustion, vent action, and vent pipe installation are very important in preventing death from possible carbon monoxide poisoning and fires, see **Figure 9** (page 10) and **Figure 10** (page 14).

Examine the location to ensure the water heater is consistent with the requirements described in **Facts to Consider About the Location** (page 8).

5. For California installation this water heater must be braced, anchored, or strapped to avoid falling or moving during an earthquake. See instructions for correct installation procedures. Instructions may be obtained from California Office of the State Architect, 400 P Street, Sacramento, CA 95814.
6. Massachusetts Code requires this water heater to be installed in accordance with **Massachusetts 248-CMR 2.00: State Plumbing Code**, and **248-CMR 5.00**.

TYPICAL INSTALLATION

GET TO KNOW YOUR WATER HEATER - GAS MODELS

A. Vent Pipe	I. Ground Joint Union	Q. Temperature-Pressure Relief Valve
B. Draft Hood	J. Sediment Trap	R. Rating Plate
C. Anode	K. Inner Door	S. Flue Baffle(s)
D. Hot Water Outlet	L. Outer Door	T. Gas Control Valve/Thermostat
E. Outlet	M. Union	U. Drain Valve
F. Insulation	N. Inlet Water Shut-off Valve	V. Pilot and Main Burner
G. Gas Supply	O. Cold Water Inlet	W. Flue
H. Manual Gas Shut-off Valve	P. Inlet Dip Tube	X. Metal Drain Pan

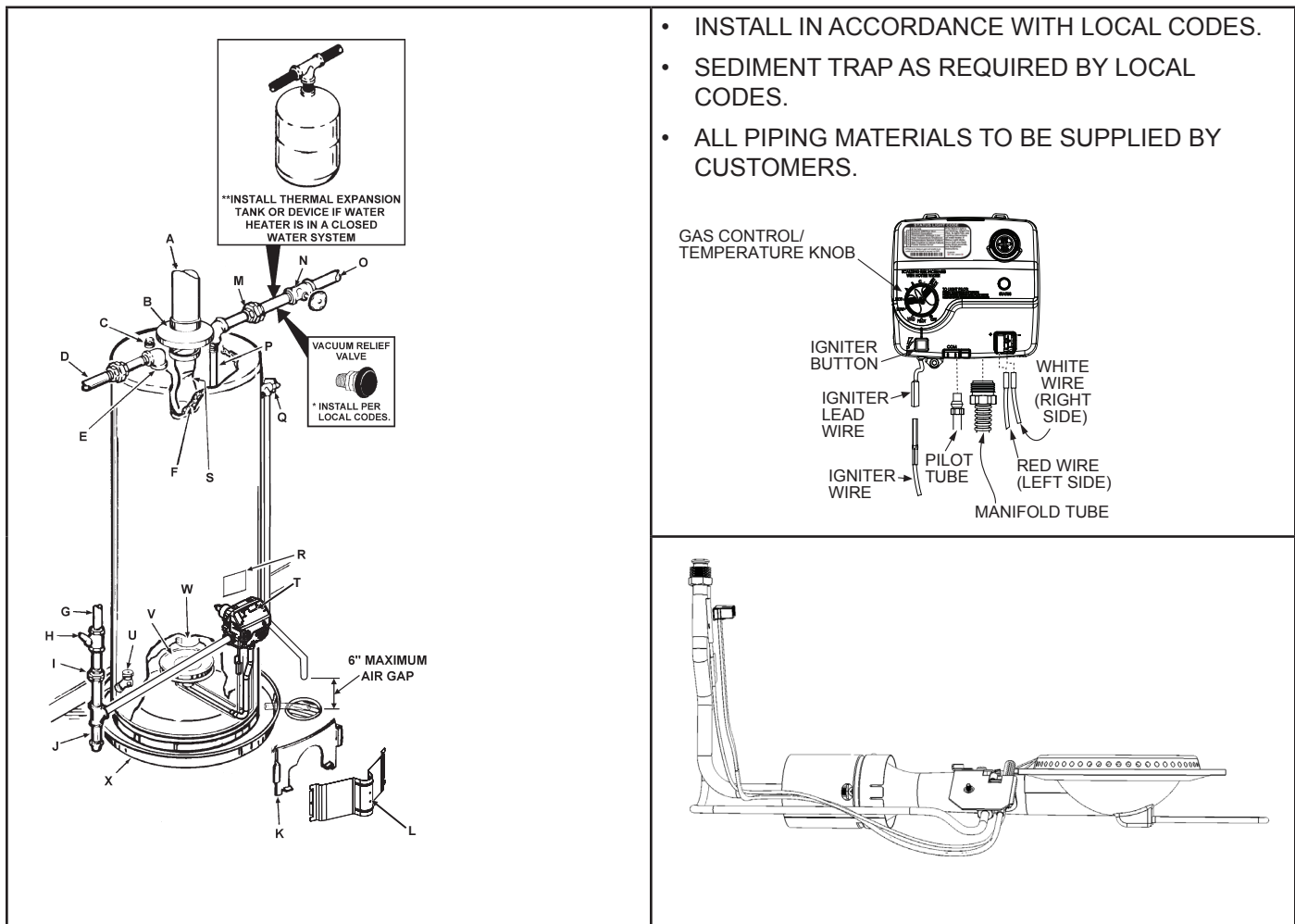

FIGURE 1. TYPICAL INSTALLATION

**CLOSED WATER SYSTEMS ARE THOSE WITH BACK FLOW PREVENTION DEVICES INSTALLED IN THE WATER SERVICE LINE.

TYPICAL INSTALLATION

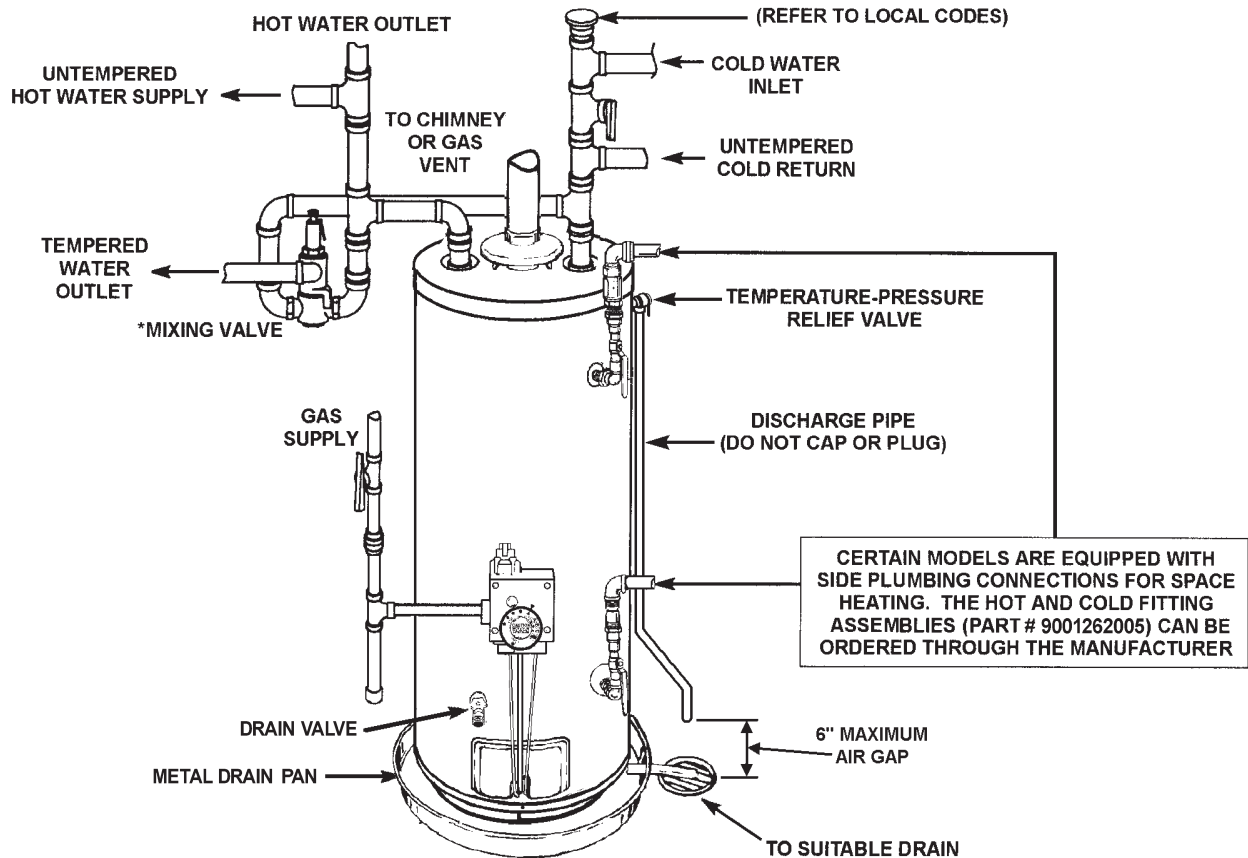

FIGURE 2. MIXING VALVE USAGE

APPLICATION/USE OF WATER HEATER

This Water Heater has been design certified as complying with *ANSI Z21.10.3-CSA 4.3* current edition for water heaters and is considered suitable for:

- Water (Potable) Heating and Space Heating*: All models are considered suitable for water (potable) heating and space heating.

*These water heaters cannot be used in space heating applications only.

HOTTER WATER CAN SCALD

Water heaters are intended to produce hot water. Water heated to a temperature which will satisfy space heating, clothes washing, dish washing, and other sanitizing needs can scald and permanently injure you upon contact. Some people are more likely to be permanently injured by hot water than others. These include the elderly, children, the infirm, or physically/mentally handicapped. If anyone using hot water in your home fits into one of these groups or if there is a local code requiring a certain temperature water at the hot water tap, then you must take special precautions. In addition to using the lowest possible temperature setting that satisfies your hot water needs, a means such as a *Mixing Valve should be used at the hot water taps used by these people or at the water heater. See *Figure 2* (page 7). Mixing valves are available at plumbing supply or hardware stores. Consult a qualified installer or service agency. Follow mixing valve manufacturer's instructions for installation of valves. Before changing the factory setting on the thermostat, see *Temperature Regulation* (page 24).

	<p>Water temperature over 125°F (52°C) can cause severe burns instantly resulting in severe injury or death.</p> <p>Children, the elderly, and the physically or mentally disabled are at highest risk for scald injury.</p> <p>Feel water before bathing or showering.</p> <p>Temperature limiting valves are available.</p> <p>Read instruction manual for safe temperature setting.</p>
--	--

TYPICAL INSTALLATION

FACTS TO CONSIDER ABOUT THE LOCATION

Carefully choose an indoor location for the new water heater, because the placement is a very important consideration for the safety of the occupants in the building and for the most economical use of the water heater. This water heater is not for use in manufactured (mobile) homes or outdoor installation.

Whether replacing an old water heater or putting the water heater in a new location, the following critical points must be observed:

1. Select a location indoors as close as practical to the gas vent or chimney to which the water heater vent is going to be connected, and as centralized with the water piping system as possible.
2. Selected location must provide adequate clearances for servicing and proper operation of the water heater.

CAUTION

Property Damage Hazard

- All water heaters eventually leak
- Do not install without adequate drainage.

Installation of water heater must be accomplished in such a manner that if the tank or any connections should leak, flow will not cause damage to the structure. For this reason, it is not advisable to install water heater in an attic or upper floor. When such locations cannot be avoided, a suitable metal drain pan should be installed under the water heater. Metal Drain pans are available at your local hardware store. Such a metal drain pan must have a minimum length and width of at least 2" (51 mm) greater than water heater dimensions and must be piped to an adequate drain. The pan must not restrict combustion air flow.

Water heater life depends upon water quality, water pressure and the environment in which the water heater is installed. Water heaters are sometimes installed in locations where leakage may result in property damage, even with the use of a drain pan piped to a drain. However, unanticipated damage can be reduced or prevented by a leak detector or water shut-off device used in conjunction with a piped drain pan. These devices are available from some plumbing supply wholesalers and retailers, and detect and react to leakage in various ways:

- Sensors mounted in the drain pan that trigger an alarm or turn off the incoming water to the water heater when leakage is detected.
- Sensors mounted in the drain pan that turn off the water supply to the entire home when water is detected in the drain pan.
- Water supply shut-off devices that activate based on the water pressure differential between the cold water and hot water pipes connected to the water heater.
- Devices that will turn off the gas supply to a gas water heater while at the same time shutting off its water supply.

WARNING

Fire or Explosion Hazard

- Avoid all ignition sources if you smell gas.
- Do not expose water heater control to excessive gas pressure.
- Use only gas shown on rating plate.
- Maintain required clearances to combustibles.
- Keep ignition sources away from faucets after extended period of non-use.



Read instruction manual before installing, using or servicing water heater.



DANGER

Fire or Explosion Hazard

- Do not store or use gasoline or other flammable vapors and liquids in the vicinity of this or any other appliance.



INSTALLATIONS IN AREAS WHERE FLAMMABLE LIQUIDS (VAPORS) ARE LIKELY TO BE PRESENT OR STORED (GARAGES, STORAGE AND UTILITY AREAS, ETC.): Flammable liquids (such as gasoline, solvents, propane [LP or butane, etc.] and other substances such as adhesives, etc.) emit flammable vapors which can be ignited by a gas water heater's pilot light or main burner.

The resulting flashback and fire can cause death or serious burns to anyone in the area, as well as property damage. If installation in such areas is your only option, then installation must be accomplished in a way that the pilot flame and main burner flame are elevated from floor at least 18 inches. While this may reduce chances of flammable vapors, from a floor spill being ignited, gasoline and other flammable substances should never be stored or used in the same room or area containing a gas water heater or other open flame or spark producing appliance.

NOTE: Flammable vapors may be drawn by air currents from other areas of the structure to the appliance.

Also, the water heater must be located and/or protected so it is not subject to physical damage by a moving vehicle.

	⚠ WARNING
	Fire Hazard
For continued protection against risk of fire:	
<ul style="list-style-type: none"> • Do not install water heater on carpeted floor. • Do not operate water heater if flood damaged. 	



This water heater must not be installed directly on carpeting. Carpeting must be protected by metal or wood panel beneath the water heater extending beyond the full width and depth of the water heater by at least 3" (76.2 mm) in any direction, or if the water heater is installed in an alcove or closet, the entire floor must be covered by the panel. Failure to heed this warning may result in a fire hazard.

HIGH ALTITUDE

⚠ WARNING	
Breathing Hazard - Carbon Monoxide Gas	
	<ul style="list-style-type: none"> • High altitude orifice must be installed if a standard model is installed above 7,700 feet (2347m). • Contact your local supplier.
	Breathing carbon monoxide can cause brain damage or death. Always read and understand instruction manual.

Water heaters covered in this manual have been tested and approved for installation at elevations up to 7,700 feet (2,347 m) above sea level. For installation above 7,700 feet (2,347 m), the water heater's Btu input should be reduced at the rate of 4 percent for each 1,000 feet (305 m) above sea level which requires replacement of the burner orifice in accordance with the National Fuel Gas Code ANSI Z223.1/NFPA 54. Contact your local gas supplier for further information.

Failure to replace the standard orifice with the proper high altitude orifice when installed at elevations above 7,700 feet (2,347 m) could result in improper and inefficient operation of the water heater, producing carbon monoxide gas in excess of the safe limits. This could result in serious injury or death. Contact your local gas supplier for any specific changes that may be required in your area.

⚠ WARNING	
Fire or Explosion Hazard	
Read instruction manual before installing, using or servicing water heater.	
	
<ul style="list-style-type: none"> • Improper use may result in fire or explosion. • Maintain required clearances to combustibles. 	

ADJUSTING AIR SHUTTER FOR HIGHER ALTITUDES

The air shutter is preset with the air shutter in the open position and for most applications changing the air shutter is not required.

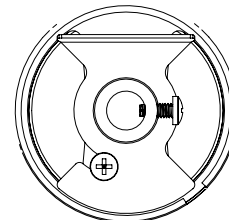
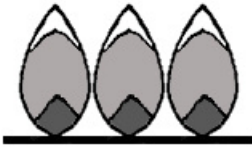

FIGURE 3. AIR SHUTTER OPEN

A correctly set burner should have a stable quiet flame. The flame will be blue with a well defined blue inner flame, Some yellow tipping is normal with LP gas. See *Figure 4*.



Normal Flames:

- Blue with well defined inner flame
- Some Yellow tipping is normal for LP gas

FIGURE 4. NORMAL FLAMES

If flames are seen to lift from the burner ports, gradually close the air shutter until a stable flame is achieved. See *Figure 5*.



Flame Lifting: Close air shutter

- Flame lifting from burner ports
- Excessive noise from flames

FIGURE 5. FLAME LIFTING

See *Figure 6* for the appearance of the half-closed and full-closed air shutter. Normally, this flame lifting occurs only at altitudes above 5,400 feet.

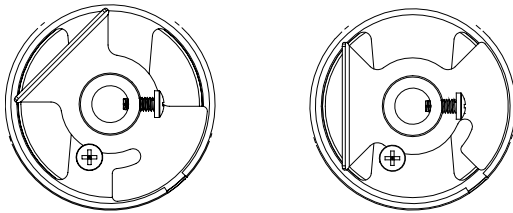

FIGURE 6. HALF-CLOSED AND CLOSED AIR SHUTTER

If the air shutter is closed too far, the flame will look hazy and not have defined cones. See the example in *Figure 7* (page 10). In this case, the air shutter will need to be opened. See *Figure 3*.



Unstable Yellow Flames: Open air Shutter

- Unstable flames - No defined cones
- Hazy yellow flame

FIGURE 7. UNSTABLE FLAME

CLEARANCES

Minimum clearances between the water heater and combustible construction are 0 inch at the sides and rear, 4" (102 mm) at the front, and 6" (153 mm) from the vent pipe. Clearance from the top of the jacket is 12" (305 mm).

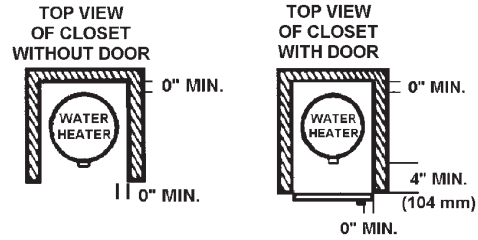
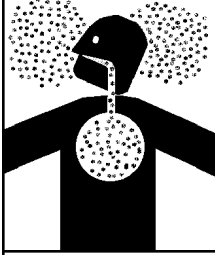

FIGURE 8. CLEARANCES

⚠ WARNING

Breathing Hazard - Carbon Monoxide Gas



- Install water heater in accordance with the instruction manual and NFPA54.
- To avoid injury, combustion and ventilation air must be taken from outdoors.
- Do not place chemical vapor emitting products near water heater.

Breathing carbon monoxide can cause brain damage or death. Always read and understand instruction manual.

A gas water heater cannot operate properly without the correct amount of air for combustion. Do not install in a confined area such as a closet, unless you provide air as described in *Air Requirements* (page 16). Never obstruct the flow of ventilation air. If you have any doubts or questions at all, call your gas supplier. Failure to provide the proper amount of combustion air can result in a fire or explosion and cause death, serious bodily injury, or property damage.

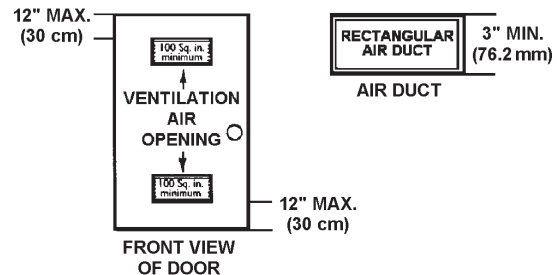



FIGURE 9. VENTILATION CLEARANCES

If this water heater will be used in beauty shops, barber shops, cleaning establishments, or self-service laundries with dry cleaning equipment, it is imperative that the water heater or water heaters be installed so that combustion and ventilation air be taken from outside these areas.

Propellants of aerosol sprays and volatile compounds, (cleaners, chlorine based chemicals, refrigerants, etc.) in addition to being highly flammable in many cases, will also change to corrosive hydrochloric acid when exposed to the combustion products of the water heater. The results can be hazardous, and also cause product failure.

INSULATION BLANKETS

 WARNING	
Breathing Hazard - Carbon Monoxide Gas	
	<ul style="list-style-type: none">• Do not obstruct water heater air intake with insulating blanket.• Gas and carbon monoxide detectors are available.• Install water heater in accordance with the instruction manual.
Breathing carbon monoxide can cause brain damage or death. Always read and understand instruction manual.	

Insulation blankets are available to the general public for external use on gas water heaters but are not necessary with these products. The purpose of an insulation blanket is to reduce the standby heat loss encountered with storage tank heaters. The water heaters covered by this manual meet or exceed the Energy Policy Act standards with respect to insulation and standby heat loss requirements, making an insulation blanket unnecessary.

Should you choose to apply an insulation blanket to this heater, you should follow these instructions. See **Leakage Test Points** (page 31) for identification of components mentioned below. Failure to follow these instructions can restrict the air flow required for proper combustion, potentially resulting in fire, asphyxiation, serious personal injury or death.

- **DO NOT** apply insulation to the top of the water heater, as this will interfere with safe operation of the draft hood. See **Figure 16** (page 20).
- **DO NOT** cover the thermostat or the temperature-pressure relief valve.
- **DO NOT** allow the insulation to come within 2 inches (5 cm) of the floor to prevent blockage of combustion air flow to the burner.
- **DO NOT** cover the instruction manual. Keep it on the side of the water heater or nearby for future reference.
- **DO** obtain new warning and instruction labels from the manufacturer for placement on the blanket directly over the existing labels.
- **DO** inspect the insulation blanket frequently to make certain it does not sag, thereby obstructing the combustion air flow.

HARD WATER

Where hard water conditions exist, water softening or the threshold type of water treatment is recommended. This will protect the dishwashers, coffee urns, water heaters, water piping and other equipment.

INSTALLATION REQUIREMENTS

GAS SUPPLY SYSTEMS

Low pressure building gas supply systems are defined as those systems that cannot under any circumstances exceed 14" W.C. (1/2 PSI Gauge). These systems do not require pressure regulation. Measurements should be taken to insure that gas pressures are stable and fall within the requirements stated on the water heater rating plate. Readings should be taken with all gas burning equipment off (static pressure) and with all gas burning equipment running at maximum rate (dynamic pressure). The gas supply pressure must be stable within 1.5" W.C. from static to dynamic pressure to provide good performance. Pressure drops that exceed 1.5" W.C. may cause rough starting, noisy combustion or nuisance outages. Increases or spikes in static pressure during off cycles may cause failure to ignite or in severe cases damage to appliance gas valves. If your low pressure system does not meet these requirements, the installer is responsible for the corrections.

High Pressure building supply systems use pressures that exceed 14" W.C. (1/2 PSI Gauge). These systems must use field supplied regulators to lower the gas pressure to less than 14" W.C. (1/2 PSI Gauge). Appliances require gas regulators that are properly sized for the water heater input and deliver the rating plate specified pressures. Gas supply systems where pressure exceeds 5 PSI often require multiple regulators to achieve desired pressures. Systems in excess of 5 PSI building pressure should be designed by gas delivery professionals for best performance. Water heaters connected to gas supply systems that exceed 14" W.C. (1/2 PSI Gauge) at any time must be equipped with a gas supply regulator.

GAS PRESSURE REQUIREMENTS

Natural gas models require a minimum gas supply pressure of 5.0" W.C. (1.24 kPa). Propane gas models require a minimum gas supply pressure of 11" W.C. (2.74 kPa). The minimum supply pressure is measured while gas is flowing (dynamic pressure). The supply pressure (dynamic) should never fall below the specified minimum supply pressure. The supply pressure should be measured with all gas fired appliances connected to the common main firing at full capacity. If the supply pressure drops more than 1.5" W.C. (0.37 kPa) as gas begins to flow to the water heater then the supply gas system including the gas line and/or the gas regulator may be restricted or undersized. See **Gas Piping** (page 21). The gas valve on all models has a maximum gas supply pressure limit of 14" W.C. (3.48 kPa) The maximum supply pressure is measured while gas is not flowing (static pressure).

SUPPLY GAS REGULATOR

The maximum allowable gas supply pressure for this water heater is 14.0 inches W.C. (3.48 kPa). Install a positive lock-up gas pressure regulator in the gas supply line if inlet gas pressure can exceed 14.0 inches W.C. (3.48 kPa) at any time. Regulators must be sized/used according to manufacturer's specifications.

If a positive lock-up regulator is required follow these instructions:

1. Positive lock-up gas pressure regulators must be rated at or above the input Btu/hr rating of the water heater they supply.
2. Positive lock-up gas pressure regulator(s) should be installed no closer than 3 feet (1 meter) and no farther than 8 feet (2.4 meters) of equivalent length from the water heater's inlet gas connection.
3. After installing the positive lock-up gas pressure regulator(s), and while the water heater is operating, an initial nominal supply pressure setting of 7.0" W.C. is recommended and will generally provide good water heater operation. Some additional adjustment may be required later to maintain a steady gas supply pressure.
4. When installing multiple water heaters in the same gas supply system it is recommended that individual positive lock-up gas pressure regulators be installed at each unit.

MIXING VALVES

⚠ DANGER

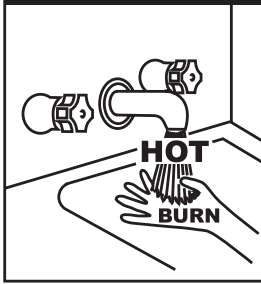

Water temperature over 125°F (52°C) can cause severe burns instantly resulting in severe injury or death.

Children, the elderly and the physically or mentally disabled are at highest risk for scald injury.

Feel water before bathing or showering.

Temperature limiting devices such as mixing valves must be installed when required by codes and to ensure safe temperatures at fixtures.

Water heated to a temperature which will satisfy clothes washing, dish washing, and other sanitizing needs can scald and cause permanent injury upon contact. Short repeated heating cycles caused by small hot water uses can cause temperatures at the point of use to exceed the water heater's temperature setting by up to 20°F (11°C).

Some people are more likely to be permanently injured by hot water than others. These include the elderly, children, the infirm and the physically/mentally disabled. **Table 1** shows the approximate time-to-burn relationship for normal adult skin. If anyone using hot water provided by the water heater being installed fits into one of these groups or if there is a local code or state law requiring a certain water temperature at the point of use, then special precautions must be taken.

In addition to using the lowest possible temperature setting that satisfies demand of the application, a mixing valve should be installed at the water heater or at hot water taps to further reduce system water temperature. See **Figure 2** (page 7)

Mixing valves are available at plumbing supply stores. Consult a Qualified Installer or Service Agency. Follow mixing valve manufacturer's instructions for installation of the valves.

TABLE 1. APPROXIMATE TIME-TO-BURN

Water Temperature °F	Time for 1st Degree Burn (Less Severe Burns)	Time for Permanent Burns 2nd & 3rd Degree (Most Severe Burns)
110	(normal shower temp.)	
116	(pain threshold)	
116	35 minutes	45 minutes
122	1 minute	5 minutes
131	5 seconds	25 seconds
140	2 seconds	5 seconds
149	1 second	2 seconds
154	instantaneous	1 second

(U.S. Government Memorandum, C.P.S.C., Peter L. Armstrong, Sept. 15, 1978)

WATER PIPING

WATER (POTABLE) HEATING AND SPACE HEATING

This water heater shall not be connected to any heating systems or component(s) used with a non-potable water heating appliance.

⚠ WARNING

Toxic Chemical Hazard

- Do not connect to non-potable water system.

All piping components connected to this unit for space heating applications shall be suitable for use with potable water. Toxic chemicals, such as those used for boiler treatment shall not be introduced into this system.

When the system requires water for space heating at temperatures higher than required for domestic water purposes, a mixing valve must be installed. See **Figure 2** (page 7) for the suggested piping arrangement.

These water heaters cannot be used in space heating applications only.

CLOSED WATER SYSTEMS

Water supply systems may, because of code requirements or such conditions as high line pressure, among others, have installed devices such as pressure reducing valves, check valves, and back flow preventers. Devices such as these cause the water system to be a closed system.

THERMAL EXPANSION

As water is heated, it expands (thermal expansion). In a closed system the volume of water will grow when it is heated. As the volume of water grows there will be a corresponding increase in water pressure due to thermal expansion. Thermal expansion can cause premature tank failure (leakage). This type of failure is not covered under the limited warranty. Thermal expansion can also cause intermittent temperature-pressure relief valve operation: water discharged from the valve due to excessive pressure build up. This condition is not covered under the limited warranty. The temperature-pressure relief valve is not intended for the constant relief of thermal expansion.

A properly sized thermal expansion tank must be installed on all closed systems to control the harmful effects of thermal expansion. Contact a local plumbing service technician to have a thermal expansion tank installed.

CAUTION

Property Damage Hazard

- Avoid water heater damage.
- Install thermal expansion tank if necessary.
- Do not apply heat to cold water inlet.
- Contact qualified installer or service agency.

TEMPERATURE-PRESSURE RELIEF VALVE

⚠ WARNING

Explosion Hazard

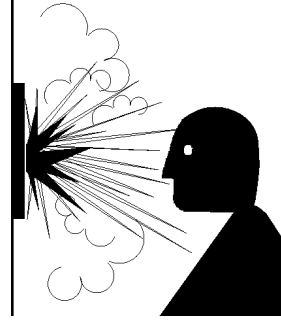

- Temperature-pressure relief valve must comply with ANSI A21.22, CSA 4.4 and ASME code.
- Properly sized temperature-relief valve must be installed in opening provided.
- Can result in overheating and excessive tank pressure.
- Can cause serious injury or death.

This water heater is provided with a properly rated/ sized and certified combination temperature-pressure relief valve (T&P valve) by the manufacturer. The valve is certified by a nationally recognized testing laboratory that maintains periodic inspection of production of listed equipment of materials as meeting the requirements for relief valves for hot water supply systems, **ANSI Z21.22 • CSA 4.4**, and the code requirements of ASME. If replaced, the new T&P valve must meet the requirements of local codes, but not less than a combination temperature-pressure relief valve rated/sized and certified as indicated in the above paragraph. The new valve must be marked with a maximum set pressure not to exceed the marked hydrostatic working pressure of the water heater (150 psi = 1,035 kPa) and a discharge capacity not less than the water heater Btu/hr or kW input rate as shown on the water heater's model rating label.

Note: In addition to the factory installed temperature-pressure relief valve on the water heater, each remote storage tank that may be installed and piped to a water heating appliance must also have its own properly sized, rated, and approved temperature-pressure relief valve installed. Call the toll free technical support phone number listed on the back cover of this manual for technical assistance in sizing a temperature-pressure relief valve for remote storage tanks.

For safe operation of the water heater, the temperature-pressure relief valve must not be removed from its designated opening nor plugged. The temperature-pressure relief valve must be installed directly into the fitting of the water heater designed for the relief valve. Install discharge piping so that any discharge will exit the pipe within 6 inches (15.2 cm) above an adequate floor drain, or external to the building. In cold climates it is recommended that it be terminated at an adequate drain inside the building. Be certain that no contact is made with any live electrical part. The discharge opening must not be blocked or reduced in size under any circumstances. Excessive length, over 30 feet (9.14 m), or the use of more than four elbows can cause restriction and reduce the discharge capacity of the valve.

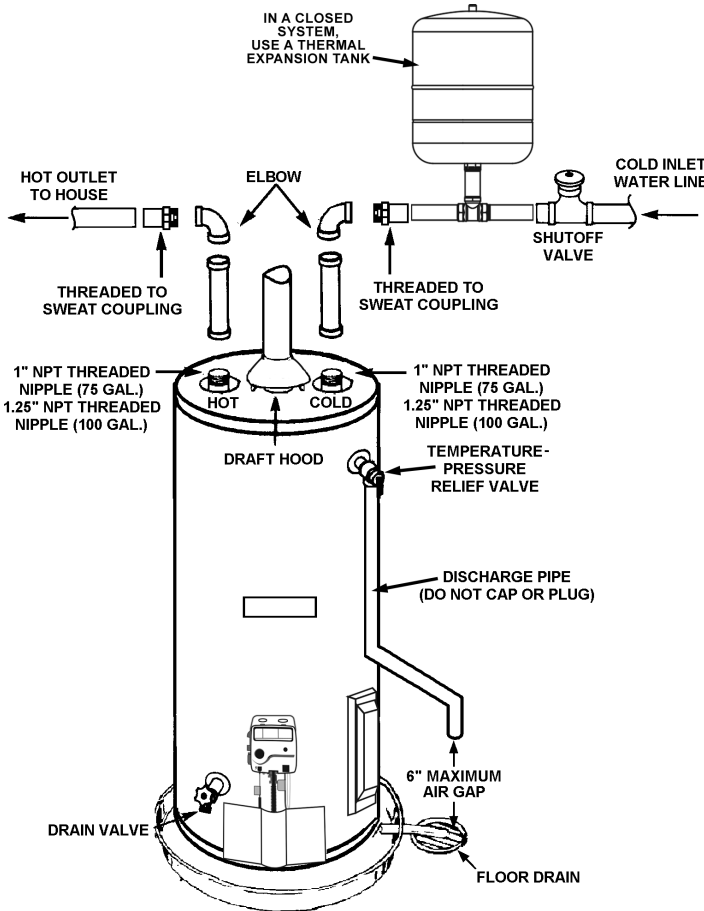

FIGURE 10. TYPICAL PIPING ARRANGEMENT

Note: To protect against untimely corrosion of hot and cold water fittings, it is strongly recommended that dielectric unions or couplings be installed on this water heater when connected to copper pipe.

Figure 10 shows the typical attachment of the water piping to the water heater. The water heater is equipped with 1" NPT threaded nipple (75 gallon nominal capacity models) or 1.25" NPT threaded nipple (100 gallon nominal capacity models) water connections.

No valve or other obstruction is to be placed between the temperature-pressure relief valve and the tank. Do not connect discharge piping directly to the drain unless a 6" (15.2 cm) air gap is provided. To prevent bodily injury, hazard to life, or property damage, the relief valve must be allowed to discharge water in adequate quantities should circumstances demand. If the discharge pipe is not connected to a drain or other suitable means, the water flow may cause property damage.

PRECAUCIÓN
Peligro de daño provocado por agua
<ul style="list-style-type: none"> • El tubo de descarga de la válvula de alivio de temperatura y presión deben finalizar en un desagüe adecuado.

T&P Valve Discharge Pipe Requirements:

- Shall not be smaller in size than the outlet pipe size of the valve, or have any reducing couplings or other restrictions.
- Shall not be plugged or blocked.
- Shall not be exposed to freezing temperatures.
- Shall be of material listed for hot water distribution.
- Shall be installed so as to allow complete drainage of both the temperature-pressure relief valve and the discharge pipe.
- Must terminate a maximum of six inches above a floor drain or external to building. In cold climates, it is recommended that discharge pipe be terminated at an adequate drain inside building.
- Shall not have any valve or other obstruction between the relief valve and the drain.

DANGER	<ul style="list-style-type: none"> • Burn hazard. • Hot water discharge. • Keep clear of Temperature-Pressure Relief Valve discharge outlet.
	

The temperature-pressure relief valve must be manually operated at least twice a year. Caution should be taken to ensure the following:

1. No one is in front of or around the outlet of the temperature-pressure relief valve discharge line.
2. The water manually discharged will not cause any bodily injury or property damage because the water may be extremely hot.

If, after manually operating the valve, it fails to completely reset and continues to release water, immediately close the cold water inlet to the water heater, follow the draining instructions in this manual, and replace the temperature-pressure relief valve with a properly rated/ sized new one.

Note: The purpose of a temperature-pressure relief valve is to prevent excessive temperatures and pressures in the storage tank. The T&P valve is not intended for the constant relief of thermal expansion. A properly sized thermal expansion tank must be installed on all closed systems to control thermal expansion, see **Figure 10** (page 13).

If you do not understand these instructions or have any questions regarding the temperature-pressure relief valve call the toll free number listed on the back cover of this manual for technical assistance.

FILLING THE WATER HEATER



Never use this water heater unless it is completely full of water. To prevent damage to the tank, the tank must be filled with water. Water must flow from the hot water faucet before turning on the gas to the water heater.

CAUTION
Property Damage Hazard
<ul style="list-style-type: none"> • Avoid water heater damage. • Fill tank with water before operating.

To fill the water heater with water:

1. Close the water heater drain valve by turning the handle to the right (clockwise). The drain valve is on the lower front of the water heater.
2. Open the cold water supply valve to the water heater. **NOTE:** The cold water supply valve must be left open when the water heater is in use.
3. To insure complete filling of the tank, allow air to exit by opening the nearest hot water faucet. Allow water to run until a constant flow is obtained. This will let air out of the water heater and the piping.
4. Check all water piping and connections for leaks. Repair as needed.

AIR REQUIREMENTS

 WARNING	
Breathing Hazard - Carbon Monoxide Gas	
	<ul style="list-style-type: none">• Install water heater in accordance with the Instruction Manual and NFPA 54 or CAN/CSA-B149.1.• To avoid injury, combustion and ventilation air must be taken from outdoors.• Do not place chemical vapor emitting products near water heater.
Breathing carbon monoxide can cause brain damage or death. Always read and understand instruction manual.	

For safe operation, an adequate supply of fresh uncontaminated air for combustion and ventilation must be provided.

An insufficient supply of air can cause recirculation of combustion products resulting in contamination that may be hazardous to life. Such a condition often will result in a yellow, luminous burner flame, causing sooting of the combustion chamber, burners, and flue tubes, and creates a risk of asphyxiation.

Do not install the water heater in a confined space unless an adequate supply of air for combustion and ventilation is brought in to that space using the methods described in **Confined Space** (page 16) that follows later in this manual.

Never obstruct the flow of ventilation air. If you have any doubts or questions at all, call your gas supplier. Failure to provide the proper amount of combustion air can result in a fire or explosion and cause property damage, serious bodily injury or death.

UNCONFINED SPACE

An **unconfined space** is one in which the volume is not less than 50 cubic feet per 1,000 Btu/hr (4.8 cubic meters per kW) of the total input rating of all appliances installed in the space. Rooms communicating directly with the space in which the appliances are installed, through openings not furnished with doors, are considered a part of the unconfined space.

Makeup air requirements for the operation of exhaust fans, kitchen ventilation systems, clothes dryers and fireplaces shall also be considered in determining the adequacy of a space to provide combustion, ventilation and dilution air.

UNUSUALLY TIGHT CONSTRUCTION

In unconfined spaces in buildings, infiltration may be adequate to provide air for combustion, ventilation and dilution of flue gases. However, in buildings of unusually tight construction (for example, weather stripping, heavily insulated, caulked, vapor barrier, etc.) additional air must be provided using the methods described in that follows.

CONFINED SPACE

A **confined space** is one in which the volume is less than 50 cubic feet per 1,000 Btu/hr (4.8 cubic meters per kW) of the total input rating of all appliances installed in the space.

Openings must be installed to provide fresh air for combustion, ventilation and dilution in confined spaces. The required size for the openings is dependent on the method used to provide fresh air to the confined space and the total Btu/hr input rating of all appliances installed in the space.

DIRECT VENT APPLIANCES

Appliances installed in a **direct-vent** configuration that derives all air for combustion from the outdoor atmosphere through sealed intake air piping are not factored in the total appliance input Btu/hr calculations used to determine the size of openings providing fresh air into confined spaces.

EXHAUST FANS

Where exhaust fans are installed, additional air shall be provided to replace the exhausted air. When an exhaust fan is installed in the same space with a water heater, sufficient openings to provide fresh air must be provided that accommodate the requirements for all appliances in the room and the exhaust fan. Undersized openings will cause air to be drawn into the room through the water heater's vent system causing poor combustion. Sooting, serious damage to the water heater and the risk of fire or explosion may result. It can also create a risk of asphyxiation.

LOUVERS AND GRILLES

The free areas of the fresh air openings in the instructions that follow do not take in to account the presence of louvers, grilles or screens in the openings.

The required size of openings for combustion, ventilation and dilution air shall be based on the “net free area” of each opening. Where the free area through a design of louver or grille or screen is known, it shall be used in calculating the size of opening required to provide the free area specified. Where the louver and grille design and free area are not known, it shall be assumed that wood louvers will have 25% free area and metal louvers and grilles will have 75% free area. Non motorized louvers and grilles shall be fixed in the open position.

FRESH AIR OPENINGS FOR CONFINED SPACES

The following instructions shall be used to calculate the size, number and placement of openings providing fresh air for combustion, ventilation and dilution in confined spaces. The illustrations shown in this section of the manual are a reference for the openings that provide fresh air into confined spaces only. Do not refer to these illustrations for the purpose of vent installation. See *Venting* (page 19) for complete venting instructions.

OUTDOOR AIR THROUGH TWO OPENINGS

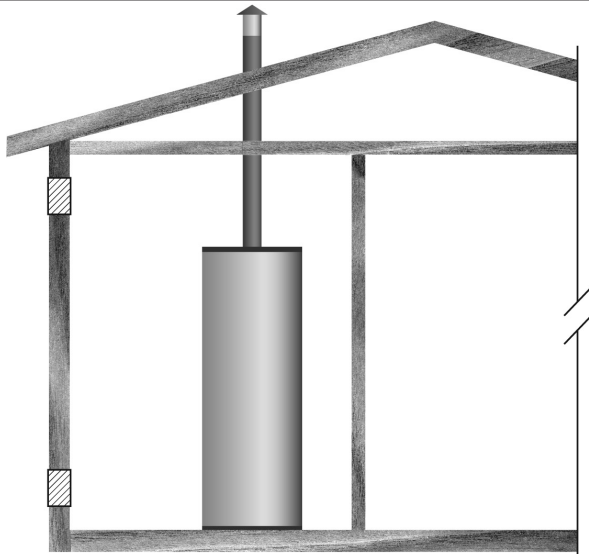

FIGURE 11. FRESH AIR FROM TWO OPENINGS

The confined space shall be provided with two permanent openings, one commencing within 12 inches (300 mm) of the top and one commencing within 12 inches (300 mm) of the bottom of the enclosure. The openings shall communicate directly with the outdoors. See *Figure 11*.

Each opening shall have a minimum free area of 1 square inch per 4,000 Btu/hr (550 mm² per kW) of the aggregate input rating of all appliances installed in the enclosure. Each opening shall not be less than 100 square inches (645 cm²).

OUTDOOR AIR THROUGH ONE OPENING

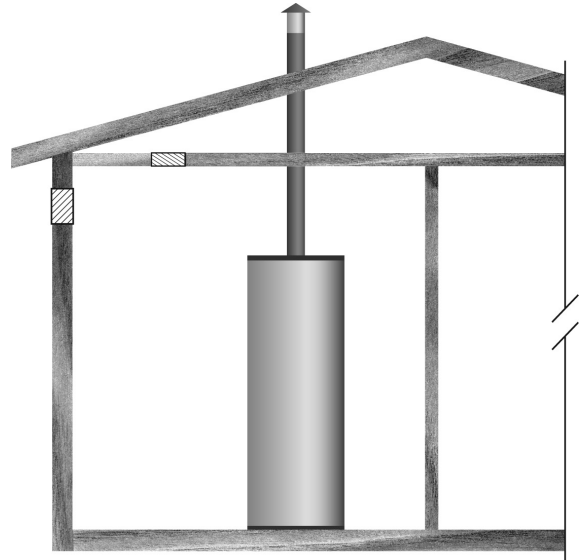

FIGURE 12. FRESH AIR FROM ONE OPENING

Alternatively a single permanent opening, commencing within 12 inches (300 mm) of the top of the enclosure, shall be provided. See *Figure 12*.

The water heater shall have clearances of at least 1 inch (25 mm) from the sides and back and 6 inches (150 mm) from the front of the appliance. The opening shall directly communicate with the outdoors or shall communicate through a vertical or horizontal duct to the outdoors or spaces that freely communicate with the outdoors and shall have a minimum free area of the following:

1. One square inch per 3000 Btu/hr (733 mm² per kW) of the total input rating of all appliances located in the enclosure, and
2. Not less than the sum of the areas of all vent connectors in the space.

OUTDOOR AIR THROUGH TWO HORIZONTAL DUCTS

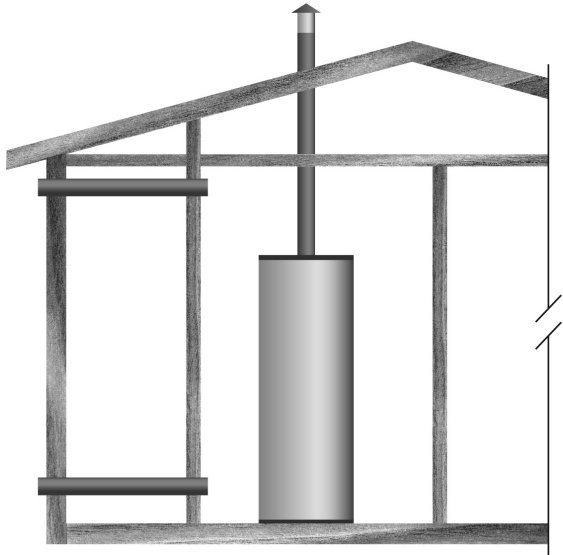

FIGURE 13. FRESH AIR FROM TWO HORIZONTAL DUCTS

The confined space shall be provided with two permanent horizontal ducts, one commencing within 12 inches (300 mm) of the top and one commencing within 12 inches (300 mm) of the bottom of the enclosure. The horizontal ducts shall communicate directly with the outdoors. See *Figure 13*.

Each duct opening shall have a minimum free area of 1 square inch per 2,000 Btu/hr (1100 mm² per kW) of the aggregate input rating of all appliances installed in the enclosure.

When ducts are used, they shall be of the same cross sectional area as the free area of the openings to which they connect. The minimum dimension of rectangular air ducts shall be not less than 3 inches.

OUTDOOR AIR THROUGH TWO VERTICAL DUCTS

The illustrations shown in this section of the manual are a reference for the openings that provide fresh air into confined spaces only.

DO NOT refer to these illustrations for the purpose of vent installation. See *Venting* (page 19) for complete venting instructions.

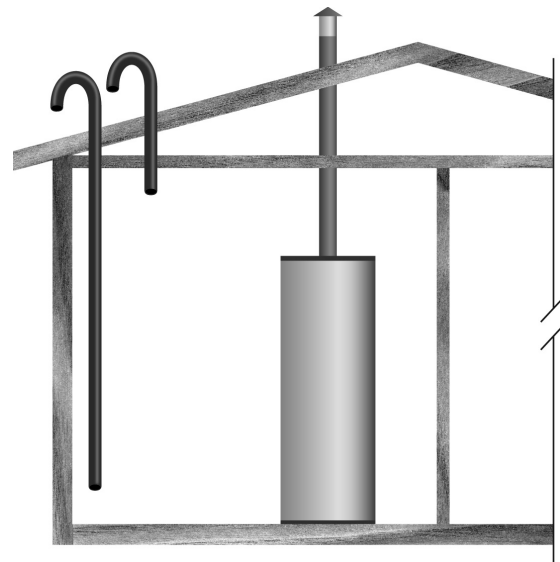

FIGURE 14. FRESH AIR FROM TWO VERTICAL DUCTS

The confined space shall be provided with two permanent vertical ducts, one commencing within 12 inches (300 mm) of the top and one commencing within 12 inches (300 mm) of the bottom of the enclosure. The vertical ducts shall communicate directly with the outdoors. See *Figure 14*.

Each duct opening shall have a minimum free area of 1 square inch per 4,000 Btu/hr (550 mm² per kW) of the aggregate input rating of all appliances installed in the enclosure.

When ducts are used, they shall be of the same cross sectional area as the free area of the openings to which they connect. The minimum dimension of rectangular air ducts shall be not less than 3 inches.

AIR FROM OTHER INDOOR SPACES

The confined space shall be provided with two permanent openings, one commencing within 12 inches (300 mm) of the top and one commencing within 12 inches (300 mm) of the bottom of the enclosure. See *Figure 15*.

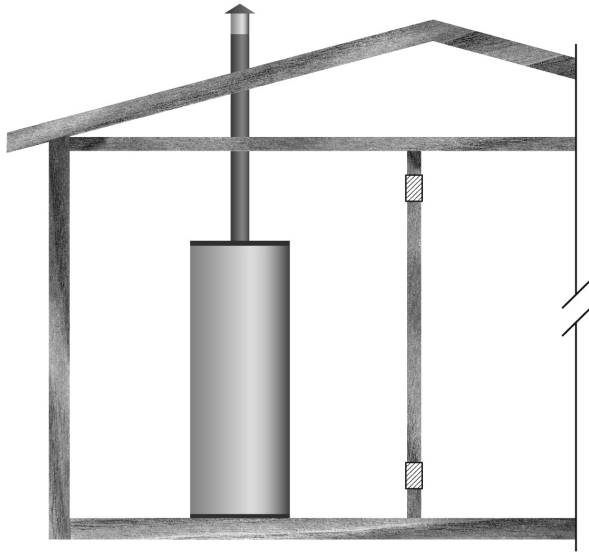

FIGURE 15. AIR FROM INDOOR SPACES

Each opening shall communicate directly with an additional room(s) of sufficient volume so that the combined volume of all spaces meets the criteria for an unconfined space.

Each opening shall have a minimum free area of 1 square inch per 1,000 Btu/hr (2200 mm² per kW) of the aggregate input rating of all appliances installed in the enclosure. Each opening shall not be less than 100 square inches (645 cm²).

VENTING

Water heaters covered by these instructions are Category I, Natural Draft appliances.

Chemical vapor corrosion of the flue and vent system may occur if air for combustion contains certain chemical vapors. Spray can propellants, cleaning solvents, refrigerator and air conditioner refrigerants, swimming pool chemicals, calcium and sodium chloride, waxes, bleach and process chemicals are typical compounds which are potentially corrosive.

VENT DAMPERS - Any vent damper, whether it is operated thermally or otherwise must be removed if its use inhibits proper drafting of the water heater.

Thermally Operated Vent Dampers: this gas-fired water heater has a thermal efficiency at or above 80% which may produce a relatively low flue gas temperature.

Such temperatures may not be high enough to properly open thermally operated vent dampers. This would cause spillage of the flue gases and may cause carbon monoxide poisoning. Vent dampers must bear evidence of certification as complying with the current edition of the **American National Standard ANSI Z21.66 CGA 6.14** (covering electrically and mechanically actuated vent dampers). Before installation of any vent damper, consult the local gas utility for further information.

To insure proper venting of this gas-fired water heater, the correct vent pipe diameter must be utilized. Any additions or deletions of other gas appliances on a common vent with this water heater may adversely affect the operation of the water heater. Consult your gas supplier if any such changes are planned.

For proper venting in certain installations, a larger diameter vent pipe may be necessary. Consult your gas supplier to aid you in determining the proper venting for your water heater from the vent tables in the current edition of the **National Fuel Gas Code ANSI Z223.1/NFPA 54**.

Periodically check the venting system for signs of obstruction or deterioration and replace if needed.

The combustion and ventilation air flow must not be obstructed.

The water heater with draft hood installed must be connected to a chimney or listed vent pipe system, which terminates to the outdoors. Never operate the water heater unless it is vented to the outdoors and has adequate air supply to avoid risks of improper operation, explosion or asphyxiation.

- For proper draft hood attachment, the draft hood legs may be angled slightly inward.
- Place the draft hood legs in the receiving holes on the top of the water heater. The legs will snap in the holes to give a tight fit. Secure draft hood with the supplied brackets.
- Place the vent pipe over the draft hood. With the vent pipe in position, drill a small hole through both the vent pipe and draft hood. Secure them together with a sheet metal screw. See **Figure 16** (page 20).

Obstructed or deteriorated vent systems may present serious health risk or asphyxiation.

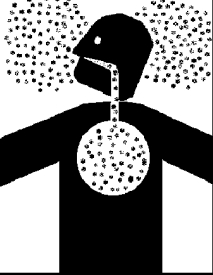
 WARNING	
Breathing Hazard - Carbon Monoxide Gas	
	<ul style="list-style-type: none"> • Vent dampers must be certified in accordance with ANSI Z21.66/CGA 6.14. • Vent damper must permit proper drafting of water heater. • Install properly sized venting. • Do not install without venting outdoors. • Do not install without drafthood. • If common vented install in accordance with NFPA 54. • Be alert for obstructed or deteriorated vent system to avoid serious injury or death.
Breathing carbon monoxide can cause brain damage or death. Always read and understand instruction manual.	

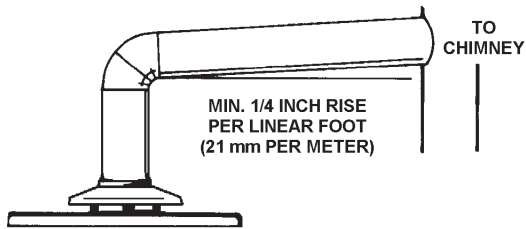

FIGURE 17. VENT PIPE MINIMUM UPWARD SLOPE

There must be a minimum of 6" (153 mm) clearance between single wall vent pipe and any combustible material. Fill and seal any clearance between single wall vent pipe and combustible material with mortar mix, cement, or other noncombustible substance. For other than single wall, follow vent pipe manufacturer's clearance specifications. To insure a tight fit of the vent pipe in a brick chimney, seal around the vent pipe with mortar mix cement.

Failure to have required clearances between vent piping and combustible material will result in a fire hazard.

Be sure vent pipe is properly connected to prevent escape of dangerous flue gases which could cause deadly asphyxiation.

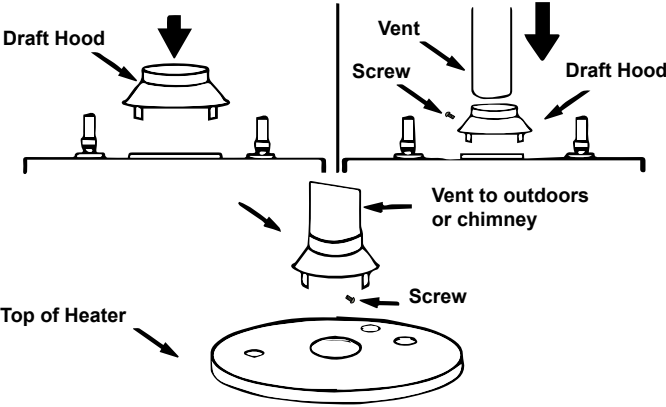

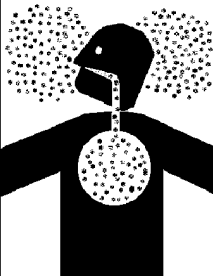

FIGURE 16. DRAFT HOOD ATTACHMENT

The vent pipe from the water heater must be no less than the diameter of the draft hood outlet on the water heater and must slope upward at least 1/4 inch per linear foot (21 mm per meter). See *Figure 17* (page 20).

All vent gases must be completely vented to the outdoors of the structure (dwelling). Install only the draft hood provided with the new water heater and no other draft hood.

Vent pipes must be secured at each joint with sheet metal screws.

 WARNING	
Breathing Hazard - Carbon Monoxide Gas	
	<ul style="list-style-type: none"> • Vent dampers must be certified in accordance with ANSI Z21.66/CGA 6.14. • Vent damper must permit proper drafting of water heater. • Install properly sized venting. • Do not install without venting outdoors. • Do not install without drafthood. • If common vented install in accordance with NFPA 54. • Be alert for obstructed or deteriorated vent system to avoid serious injury or death.
Breathing carbon monoxide can cause brain damage or death. Always read and understand instruction manual.	

Chemical vapor corrosion of the flue and vent system may occur if air for combustion contains certain chemical vapors. Spray can propellants, cleaning solvents, refrigerator and air conditioner refrigerants, swimming pool chemicals, calcium and sodium chloride, waxes, bleach and process chemicals are typical compounds which are potentially corrosive.

GAS PIPING

Contact your local gas service company to ensure that adequate gas service is available and to review applicable installation codes for your area.



⚠ WARNING

Fire and Explosion Hazard

- Do not use water heater with any gas other than the gas shown on the rating plate.
- Excessive pressure to gas control valve can cause serious injury or death.
- Turn off gas lines during installation.
- Contact qualified installer or service agency.

Size the main gas line in accordance with **Table 2** and **Table 3**. The sizes shown are for straight lengths of pipe at 0.5 in. W.C. pressure drop, which is considered normal for low pressure systems. Note: Fittings such as elbows, tees and line regulators will add to the pipe pressure drop. Also refer to the current editions of the **National Fuel Gas Code (NFPA 54)**.

Make sure gas supplied is same type listed on model rating plate. The inlet gas pressure must not exceed 14 inch water column (2.6 kPa) for natural and propane (L.P.) gas. The minimum inlet gas pressure shown on rating plate is that which will permit firing at rated input.

If the gas control valve is subjected to pressures exceeding 1/2 pound per square inch (3.5 kPa), the damage to the gas control valve could result in a fire or explosion from leaking gas.

If the main gas line shut-off serving all gas appliances is used, also turn "off" the gas at each appliance. Leave all gas appliances shut "off" until the water heater installation is complete.

A gas line of sufficient size must be run to the water heater. Consult the current edition of **National Fuel Gas Code ANSI Z223.1/NFPA 54** and your gas supplier concerning pipe size.

The gas piping must include the following:

- A readily accessible manual shut off valve in the gas supply line serving the water heater, and
- A sediment trap ahead of the gas control valve to help prevent dirt and foreign materials from entering the gas control valve.

- A flexible gas connector or a ground joint union between the shut off valve and control valve to permit servicing of the unit.

Be sure to check all the gas piping for leaks before lighting the water heater. Use a soapy water solution, not a match or open flame. Rinse off soapy solution and wipe dry.

The minimum inlet gas pressure shown on the rating plate is that which will permit firing at the rated input.

GAS SUPPLY LINE SIZES (IN INCHES)* MAXIMUM CAPACITY OF PIPE IN CUBIC FEET PER HOUR

TABLE 2. INPUT IN THOUSANDS (BTU/HR)

LENGTH IN FEET	NOMINAL IRON PIPE SIZES (INCHES)								
	1/2"	3/4"	1"	1 1/4"	1 1/2"	2"	2 1/2"	3"	4"
10	175	360	680	1400	2100	3960	6300	11000	23000
20	120	250	465	950	1460	2750	4360	7700	15800
30	97	200	375	770	1180	2200	3520	6250	12800
40	82	170	320	660	990	1900	3000	5300	10900
50	73	151	285	580	900	1680	2650	4750	9700
60	66	138	260	530	810	1520	2400	4300	8800
70	61	125	240	490	750	1400	2250	3900	8100
80	57	118	220	460	690	1300	2050	3700	7500
90	53	110	205	430	650	1220	1950	3450	7200
100	50	103	195	400	620	1150	1850	3250	6700
125	44	93	175	360	550	1020	1650	2950	6000
150	40	84	160	325	500	950	1500	2650	5500
175	37	77	145	300	460	850	1370	2450	5000
200	35	72	135	280	430	800	1280	2280	4600

TABLE 3. INPUT IN KW

LENGTH IN METERS	NOMINAL IRON PIPE SIZES (INCHES)								
	1/2"	3/4"	1"	1 1/4"	1 1/2"	2"	2 1/2"	3"	4"
3	51	105	199	410	615	1160	1845	3221	6735
6	35	73	142	278	428	805	1277	2255	4626
9	28	59	110	225	346	644	1031	1830	3748
12	24	50	94	193	290	556	878	1552	3192
15	21	44	83	170	264	492	776	1391	2840
18	19	40	76	155	237	445	703	1259	2577
21	18	37	70	143	220	410	659	1142	2372
24	17	35	64	135	202	381	600	1083	2196
27	16	32	60	126	190	357	571	1010	2108
31	15	30	57	117	182	337	542	952	1962
38	13	27	51	105	161	299	483	864	1757
46	12	25	47	95	146	278	439	776	1610
53	11	23	42	88	135	249	401	717	1464
61	10	21	40	82	126	234	375	688	1347



⚠ WARNING

Fire and Explosion Hazard

- Do not use water heater with any gas other than the gas shown on the rating plate.
- Excessive pressure to gas control valve can cause serious injury or death.
- Turn off gas lines during installation.
- Contact qualified installer or service agency.

Use pipe joint compound or teflon tape marked as being resistant to the action of petroleum [Propane (L.P.)] gases.

The water heater and its gas connection must be leak tested before placing the water heater in operation.

The water heater and its individual shut-off valve shall be disconnected from the gas supply piping system during any pressure testing of that system at test pressures in excess of 1/2 pound per square inch (3.5 kPa). It shall be isolated from the gas supply piping system by closing its individual manual shut-off valve during any pressure testing of the gas supply piping system at test pressures equal to or less than 1/2 pound per square inch (3.5 kPa).

Connecting the gas piping to the gas control valve of the water heater can be accomplished by either of the two methods shown in **Figure 18** and **Figure 19**.

SEDIMENT TRAPS

A sediment trap shall be installed as close to the inlet of the water heater as practical at the time of water heater installation. The sediment trap shall be either a tee fitting with a capped nipple in the bottom outlet or other device recognized as an effective sediment trap. If a tee fitting is used, it shall be installed in conformance with one of the methods of installation shown in **Figure 18** and **Figure 19**.

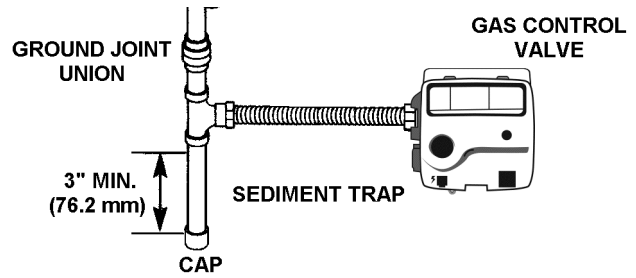

FIGURE 18. GAS PIPING WITH FLEXIBLE CONNECTOR.

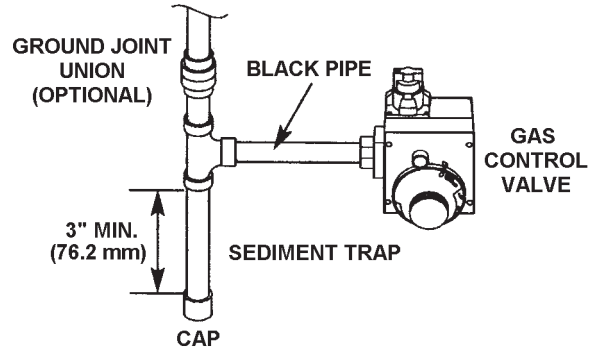

FIGURE 19. GAS PIPING WITH BLACK IRON PIPE

Contaminants in the gas lines may cause improper operation of the gas control valve that may result in fire or explosion. Before attaching the gas line be sure that all gas pipe is clean on the inside. To trap any dirt or foreign material in the gas supply line, a sediment trap must be incorporated in the piping. The sediment trap must be readily accessible. Install in accordance with the "Gas Piping" section. Refer to the current edition of the **National Fuel Gas Code, ANSI Z223.1/NFPA 54**. Short repeated heating cycles caused by small hot water

FOR YOUR SAFETY READ BEFORE LIGHTING



WARNING: If you do not follow these instructions exactly, a fire or explosion may result causing property damage, personal injury or loss of life.



BEFORE LIGHTING: ENTIRE SYSTEM MUST BE FILLED WITH WATER AND AIR PURGED FROM ALL LINES

- A. This appliance has a pilot which is lit by a piezo-electric spark gas ignition system. Do **not** open the inner door of the appliance and try to light the pilot by hand.
- B. BEFORE LIGHTING smell all around the appliance area for gas. Be sure to smell next to the floor because some gas is heavier than air and will settle on the floor.
- WHAT TO DO IF YOU SMELL GAS
- Do not try to light any appliance.
 - Do not touch any electric switch; do not use any phone in your building.
 - Immediately call your gas supplier from a neighbor's phone. Follow the gas supplier's instructions.
 - If you cannot reach your gas supplier, call the fire department.
- C. Use only your hand to push in or turn the gas control knob. Never use tools. If the knob will not push in or turn by hand, don't try to repair it, call a qualified service technician. Force or attempted repair may result in a fire or explosion.
- D. Do not use this appliance if any part has been under water. Immediately contact a qualified installer or service agency to replace a flooded water heater. Do not attempt to repair the unit! It must be replaced!
- E. DO NOT USE THIS APPLIANCE IF THERE HAS BEEN AN IGNITION OF VAPORS. Immediately call a qualified service technician to inspect the appliance. Water heaters subjected to a flammable vapors ignition will show a discoloration on the air intake grid and require replacement of the entire water heater.

LIGHTING INSTRUCTIONS

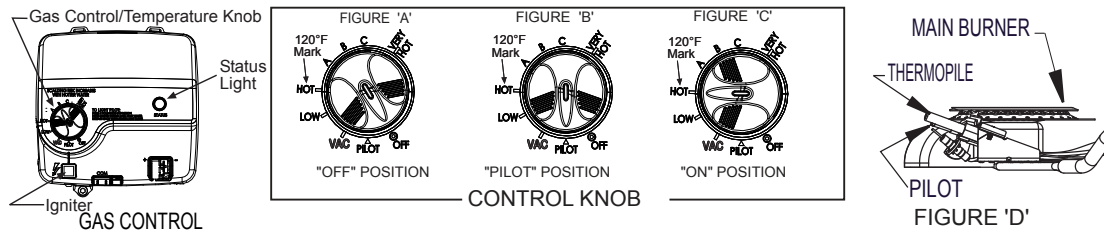

1. STOP! It is imperative that you read all safety warnings before lighting the pilot.
2. Turn the gas control/temperature knob counterclockwise ↺ to the "OFF" setting.
3. Wait ten (10) minutes to clear out any gas. If you then smell gas, STOP! Follow "B" in the safety information above on this label. If you do not smell gas, go to the next step.
4. Turn the gas control/temperature knob clockwise ↻ to "PILOT". See Figure 'B'.
5. Press the gas control/temperature knob all the way in and hold it in. The knob should travel in about 1/4 inch (6.35 mm) if it is set to "PILOT" correctly. While holding the gas control/temperature knob in, click the igniter button continuously (about once a second) for up to 90 seconds or until Status Light begins to blink.
6. When the status light starts blinking, release the gas control/temperature knob. Set the gas control/

temperature knob to the desired setting. See Figure 'C'. If the status light does not start blinking within 90 seconds, repeat steps 2 through 5 up to THREE (3) times, waiting 10 minutes between lighting attempts. The circuitry in this advanced gas valve requires that you wait 10 minutes between lighting attempts. If the status light turns solid red, release the gas control/temperature knob and repeat steps 2 through 5 (waiting 10 minutes before attempting to relight the pilot). If the status light does not start blinking after three lighting attempts, turn the gas control/temperature knob to "OFF" and call a qualified service technician or your gas supplier.



DANGER: Hotter water increases the risk of scald injury. Consult the instruction manual before changing temperature.

Refer to the Lighting Instructions in the Installation Manual for more detailed troubleshooting information.

TO TURN OFF GAS TO APPLIANCE

1. Turn the gas control/temperature knob counterclockwise ↺ to the "OFF" setting. The status light will stop blinking and stay on for a short time after the water heater is turned off. See Figure 'A'.

TEMPERATURE REGULATION

Short repeated heating cycles caused by small hot water uses can cause the temperature to exceed the thermostat setting by up to 30°F (16.7°C). If you experience this type of use you should consider using lower temperature settings to reduce scald hazards.

Any water heater's intended purpose is to heat water. Hot water is needed for cleansing, cleaning, and sanitizing (bodies, dishes, clothing). Untempered hot water can present a scald hazard. Depending on the time element, and the people involved (adults, children, elderly, infirm, etc.) scalding may occur at different temperatures.

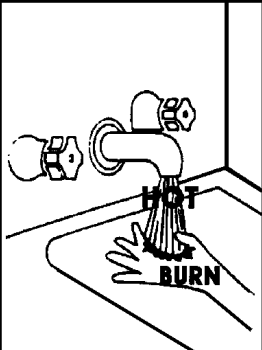
	⚠ DANGER
	Water temperature over 125°F (52°C) can cause severe burns instantly resulting in severe injury or death.
	Children, the elderly, and the physically or mentally disabled are at highest risk for scald injury.
	Feel water before bathing or showering.
	Temperature limiting valves are available.
Read instruction manual for safe temperature setting.	

HOTTER WATER CAN SCALD: Water heaters are intended to produce hot water. Water heated to a temperature which will satisfy space heating, clothes washing, dish washing, and other sanitizing needs can scald and permanently injure you upon contact. See **Table 1** (page 13).

Some people are more likely to be permanently injured by hot water than others. These include the elderly, children, the infirm, or physically/mentally handicapped. If anyone using hot water in your home fits into one of these groups or if there is a local code or state law requiring a certain temperature water at the hot water tap, then you must take special precautions. In addition to using the lowest possible temperature setting that satisfies your hot water needs, a means such as a mixing valve should be used at the hot water taps used by these people or at the water heater. Mixing valves are available at plumbing supply or hardware stores, see **Figure 2** (page 7). Follow manufacturer's instructions for installation of the valves. Before changing the factory setting on the thermostat, read this section and see **Figure 20**.

WATER TEMPERATURE ADJUSTMENT

The water temperature setting can be adjusted from 55°F to 160°F. Turn the Gas Control/Temperature Knob to the desired setting/temperature.

NOTE:

The temperatures indicated are approximates. The actual temperature of the heated water may vary.

STANDARD MODE

The controller adjusts the water heater to maintain the temperature set by the user.

VACATION SETTING

The Vacation setting (VAC) sets the controller at approximately 55°F. This setting is recommended when the water heater is not in use for a long period of time. This effectively turns the controller temperature setting down to a temperature that prevents the water in the water heater from freezing while still conserving energy.

STATUS LIGHT CODE

Normal Flashes:

- 0 Flashes Indicates Control Off/Pilot Out.
- 1 Flash Indicates Normal Operation.
- A solid red light indicates that the gas control valve/thermostat is shutting down.

See **Table 5** (page 34) for detailed diagnostic information.

Never allow small children to use a hot water tap, or to draw their own bath water. Never leave a child or handicapped person unattended in a bathtub or shower.

NOTE: A water temperature range of 120°F-140°F (49°C-60°C) is recommended by most dishwasher manufacturers.

The thermostat is adjusted to the pilot position when it is shipped from the factory. Water temperature can be regulated by moving the temperature dial to the preferred setting. The preferred starting point is 120°F at the "HOT" setting. Align the knob with the desired water temperature as shown in **Figure 20**. There is a hot water scald potential if the thermostat is set too high.

If overheating occurs or the gas supply fails to shut off, turn off the manual gas control valve to the water heater.

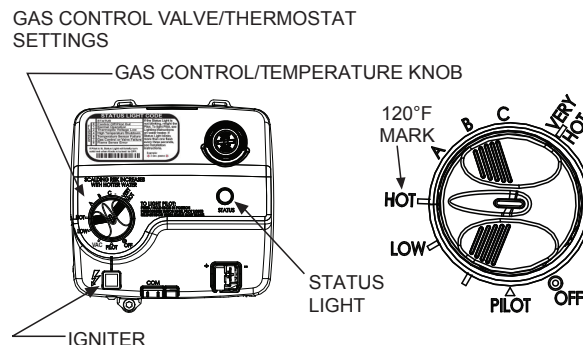

FIGURE 20. GAS CONTROL/TEMPERATURE KNOB

START-UP CONDITIONS

DRAFT HOOD OPERATIONS

Check draft hood operation by performing a worst case depressurization of the building. With all doors and windows closed, and with all air handling equipment and exhaust fans operating such as furnaces, clothes dryers, range hoods and bathroom fans, a match flame should still be drawn into the draft hood of the water heater with its burner firing. If the flame is not drawn toward the draft hood, shut off water heater and make necessary air supply changes to correct.

CONDENSATION

Whenever the water heater is filled with cold water, some condensate will form while the burner is on. A water heater may appear to be leaking when in fact the water is condensation. This usually happens one of the following occurs:

- A. A new water heater is filled with cold water for the first time.
- B. Burning gas produces water vapor in water heaters, particularly high efficiency models where flue temperatures are lower.
- C. Large amounts of hot water are used in a short time and the refill water in the tank is very cold.

Moisture from the products of combustion condense on the cooler tank surfaces and form drops of water which may fall onto the burner or other hot surfaces to produce a “sizzling” or “frying” noise.

Excessive condensation can cause pilot outage due to water running down the flue tube onto the main burner and putting out the pilot.

CHECKING GAS INPUT

With this heater in operation, determine whether it is receiving the full rated input of gas. This may be done by timing the gas meter and measuring gas pressure with a gauge or manometer. When the heater is operating at full capacity (full gas input) it should consume approximately 1 cubic foot of gas in the time shown in Table 5.

TABLE 4. INPUT CHECK TIME REQUIRED TO CONSUME 1 CU. FT. OF GAS

Model	Type of Gas	BTU Per Cu. Ft.	Approx. Time Required To Consume 1 Cu. Ft. of Gas
75	Natural	1050	50.3 sec. 119.8 sec.
	Propane	2500	
100	Natural	1050	50.3 sec. 119.8 sec.
	Propane	2500	

Use this formula to “clock” the meter. Be sure that other gas consuming appliances are not operating during this interval.

$$\frac{3,600 \times H}{T} = \text{Btu/Hr}$$

T = Time in seconds needed to burn one cubic foot of gas.

H = Heating value of gas in Btu's per cubic foot of gas.

Btu/Hr = Actual heater input rate.

Example:

$$T = 50.3 \text{ seconds/ft}^3$$

$$H = 1,050 \text{ Btu/ft}^3 \text{ (natural gas)}$$

$$\text{Btu/Hr} = ?$$

$$\frac{3,600 \times 1,050}{50.3} = 75,100 \text{ Btu/Hr (22.0 kW)}$$

Compare the actual input rate to that given on the heater's rating plate. In the example, the full input rate should be 75,100 Btu/Hr for natural gas.

Because of the suddenness and amount of water, condensation water may be diagnosed as a “tank leak”. After the water in the tank warms up (about 1-2 hours), the condition should disappear.

Do not assume the water heater is leaking until there has been enough time for the water in the tank to warm up.

An undersized water heater will cause more condensation. The water heater must be sized properly to meet the family's demands for hot water including dishwashers, washing machines and shower heads.

Excessive condensation may be noticed during the winter and early spring months when incoming water temperatures are at their lowest.

Good venting is essential for a gas fired water heater to operate properly as well as to carry away products of combustion and water vapor.

SMOKE/ODOR

It is not uncommon to experience a small amount of smoke and odor during the initial start-up. This is due to burning off of oil from metal parts, and will disappear in a short while.

STRANGE SOUNDS

Possible noises due to expansion and contraction of some metal parts during periods of heat-up and cool-down do not necessarily represent harmful or dangerous conditions.

Condensation causes sizzling and popping within the burner area during heating and cooling periods and should be considered normal.

OPERATIONAL CONDITIONS

SMELLY WATER

In each water heater there is installed at least one anode rod (see parts section) for corrosion protection of the tank. Certain water conditions will cause a reaction between this rod and the water. The most common complaint associated with the anode rod is one of a "rotten egg smell" in the hot water. This odor is derived hydrogen sulfide gas dissolved in the water. The smell is the result of four factors which must all be present for the odor to develop:

- A. A concentration of sulfate in the supply water.
- B. Little or no dissolved oxygen in the water.
- C. A sulfate reducing bacteria which has accumulated within the water heater (this harmless bacteria is nontoxic to humans).
- D. An excess of active hydrogen in the tank. This is caused by the corrosion protective action of the anode.

Smelly water may be eliminated or reduced in some water heater models by replacing the anode(s) with one of less active material, and then chlorinating the water heater tank and all hot water lines.

Contact the local water heater supplier or service agency for further information concerning an Anode Replacement Kit and this chlorination treatment.

If the smelly water persists after the anode replacement and chlorination treatment, we can only suggest that chlorination or aeration of the water supply be considered to eliminate the water problem.

Do not remove the anode leaving the tank unprotected. By doing so, all warranty on the water heater tank is voided.

AIR IN HOT WATER FAUCETS

HYDROGEN GAS: Hydrogen gas can be produced in a hot water system that has not been used for a long period of time (generally two weeks or more). Hydrogen gas is extremely flammable and explosive. To prevent the possibility of injury under these conditions, we recommend the hot water faucet, located farthest away, be opened for several minutes before any electrical appliances which are connected to the hot water system are used (such as a dishwasher or washing machine). If hydrogen gas is present, there will probably be an unusual sound similar to air escaping through the pipe as the hot water faucet is opened. There must be no smoking or open flame near the faucet at the time it is open.

TEMPERATURE-EXCEEDED SAFETY SHUT-OFF SYSTEM

This water heater is equipped with an automatic gas Shut-off system. This system works when high water temperatures are present. The high temperature Shut-off is built into the gas control valve. It is non-resettable. If the high temperature Shut-off activates, the gas control valve must be replaced. Contact your gas supplier or service agency. Turn "OFF" the entire gas supply to the water heater.

See the 4-flash error code in **Table 5** (page 34) for troubleshooting.

PERIODIC MAINTENANCE

VENTING SYSTEM INSPECTION

! WARNING

Carbon Monoxide and Fire Hazard



- Flue gases may escape if vent pipe is not connected.
- Be alert for obstructed, sooted or deteriorated vent system to avoid serious injury or death.
- Do not store corrosive chemicals in vicinity of water heater.
- Chemical corrosion of flue and vent system can cause serious injury or death.
- Contact a qualified installer or service agency.

Breathing carbon monoxide can cause brain damage or death. Always read and understand instruction manual.

At least once a year a visual inspection should be made of the venting system. You should look for:

1. Obstructions which could cause improper venting. The combustion and ventilation air flow must not be obstructed.
2. Damage or deterioration which could cause improper venting or leakage of combustion products.
3. Rusted flakes around top of water heater.

Be sure the vent piping is properly connected to prevent escape of dangerous flue gases which could cause deadly asphyxiation.

Obstructions and deteriorated vent systems may present serious health risk or asphyxiation.

Chemical vapor corrosion of the flue and vent system may occur if air for combustion contains certain chemical vapors. Spray can propellants, cleaning solvents, refrigerator and air conditioner refrigerants, swimming pool chemicals, calcium and sodium chloride, waxes, bleach and process chemicals are typical compounds which are potentially corrosive.

If after inspection of vent system you found sooting or deterioration, something is wrong. Call the local gas utility to correct problem and clean or replace the flue and venting before resuming operation of water heater.

BURNER INSPECTION

Flood damage to a water heater may not be readily visible or immediately detectable. However, over a period of time a flooded water heater will create dangerous conditions which can cause DEATH, SERIOUS BODILY INJURY, OR PROPERTY DAMAGE. Contact a qualified installer or service agency to replace a flooded water heater. Do not attempt to repair the unit! It must be replaced!

At least once a year a visual inspection should be made of the main burner and pilot burner, see **Figure 21**. You should check for sooting. Soot is not normal and will impair proper combustion.

Soot build-up indicates a problem that requires correction before further use. Turn OFF gas to water heater and leave off until repairs are made, because failure to correct the cause of the sooting can result in a fire causing death, serious injury, or property damage.

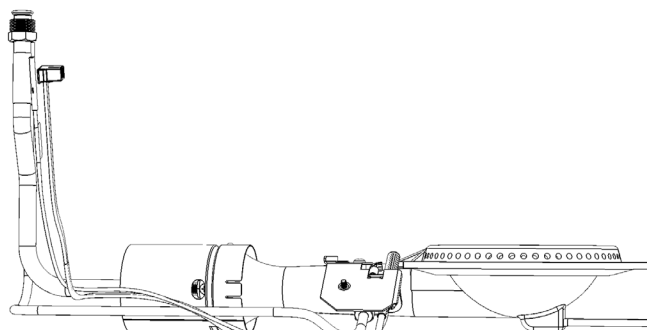

FIGURE 21. GAS BURNER ASSEMBLY

BURNER CLEANING

If inspection of the burner shows that cleaning is required, turn the gas control knob clockwise (↻) to the OFF position, depressing slightly.

NOTE: The knob cannot be turned from PILOT to OFF unless knob is depressed slightly. DO NOT FORCE.

Loose deposits on or around the burner can be removed by carefully using the hose of a vacuum cleaner inserted through the access door of the water heater. If the burner needs to be removed for additional cleaning, call a service agency to remove and clean the burner and correct the problem that required the burner to be cleaned.

AIR SHUTTER ADJUSTMENT

If the installation is at a high elevation and the burner flame exhibits flame lifting and/or noise, do the following:

1. Use a screw driver to loosen the air shutter screw.
2. Adjust the air shutter by rotating the shutter. Counter clockwise to close and Clockwise to open.
 - a. Close air shutter - to prevent noisy flames that are lifting from the burner ports.
 - b. Open air shutter – to reduce yellow tipping of the flame. (A small number of yellow tips can be normal to LP gases.)
3. Tighten the air shutter screw to secure the air shutter.

See *Adjusting Air Shutter for Higher Altitudes* (page 9).

HOUSEKEEPING

	⚠ ADVERTENCIA
	Peligro de incendio y explosión <ul style="list-style-type: none">• No obstruya las aberturas para el aire de combustión en la parte inferior del calentador de agua.• No use ni almacene vapores inflamables, como gasolina, solventes o adhesivos en la misma habitación o área cerca del calentador de agua u otro artefacto.• Puede producir lesiones graves o la muerte.

Vacuum around base of water heater for dust, dirt, and lint on a regular basis.

INSTALLED IN SUITABLE AREA: To insure sufficient ventilation and combustion air supply, proper clearances from the water heater must be maintained. See *Facts to Consider About the Location* (page 8). Combustible materials such as clothing, cleaning materials, or flammable liquids, etc. must not be placed against or adjacent to the water heater which can cause a fire.

ANODE ROD INSPECTION

CAUTION
Property Damage Hazard
<ul style="list-style-type: none">• Avoid water heater damage.• Inspection and replacement of anode rod as needed.

Remove and inspect the anode rod. See *Figure 1* (page 6) for location of the anode rod. Replace the anode rod if it is depleted.

Anode rods from new (top) to partially depleted (middle) to fully depleted stage (bottom).

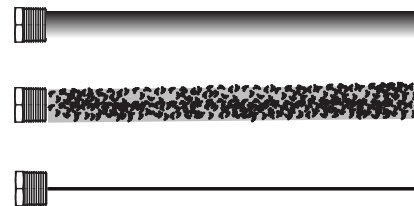
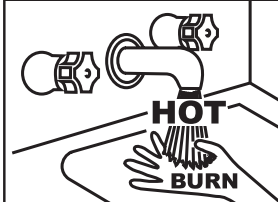

FIGURE 18. Anode Depletion

The anode rod is a sacrificial metal rod that helps reduce corrosion and premature failure (leaks) in the tank. The anode rod is a consumable item. Inspect the anode rod after the first six months of operation or when you drain and flush the tank. Replace the anode rod if it is substantially worn out or depleted. Thereafter, inspect the anode rod annually or more frequently if needed. If you use a water softener, your anode rod will deplete faster than normal. Inspect the anode rod more frequently, replacing the anode rod as needed. Obtain new anode rods from your local plumbing supplier or have a qualified person replace it. (Anode rods are a consumable item and are not covered under warranty).

TEMPERATURE-PRESSURE RELIEF VALVE TEST

⚠ DANGER	<ul style="list-style-type: none">• Burn hazard.• Hot water discharge.• Keep clear of Temperature-Pressure Relief Valve discharge outlet.
	

It is recommended that the temperature-pressure relief valve should be checked to ensure that it is in operating condition every 6 months.

When checking the temperature-pressure relief valve operation, make sure that (1) no one is in front of or around the outlet of the temperature-pressure relief valve discharge line, and (2) that the water discharge will not cause any property damage, as the water may

be extremely hot. Use care when operating valve as the valve may be hot.

To check the relief valve, lift the lever at the end of the valve several times, see **Figure 22**. The valve should seat properly and operate freely.

If after manually operating the valve, it fails to completely reset and continues to release water, immediately close the cold water inlet to the water heater and drain the water heater, see **Draining and Flushing** (page 30). Replace the temperature-pressure relief valve with a properly rated/sized new one, see **Temperature-Pressure Relief Valve** (page 14) for information on replacement.

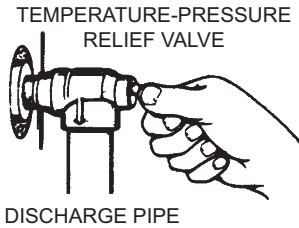

FIGURE 22. CHECKING THE RELIEF VALVE

If the temperature-pressure relief valve on the water heater weeps or discharges periodically, this may be due to thermal expansion.

NOTE: Excessive water pressure is the most common cause of temperature-pressure relief valve leakage. Excessive water system pressure is most often caused by thermal expansion in a “closed system.” See **Closed Water Systems** (page 13) and **Thermal Expansion** (page 13). The temperature-pressure relief valve is not intended for the constant relief of thermal expansion.

Temperature-pressure relief valve leakage due to pressure build up in a closed system that does not have a thermal expansion tank installed is not covered under the limited warranty. Thermal expansion tanks must be installed on all closed water systems.

DO NOT PLUG THE TEMPERATURE-PRESSURE RELIEF VALVE OPENING. THIS CAN CAUSE PROPERTY DAMAGE, SERIOUS INJURY OR DEATH.

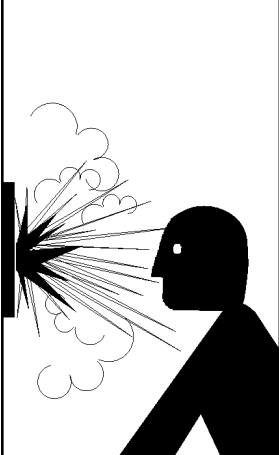
⚠ WARNING	
Explosion Hazard	
	• Temperature-pressure relief valve must comply with ANSI A21.22, CSA 4.4 and ASME code.
	• Properly sized temperature-relief valve must be installed in opening provided.
	• Can result in overheating and excessive tank pressure.
	• Can cause serious injury or death.

DRAINING AND FLUSHING

It is recommended that the water heater storage tank be drained and flushed every 6 months to reduce sediment buildup. The water heater should be drained if being shut down during freezing temperatures. See **Figure 25** for the location of the water heater components described below.

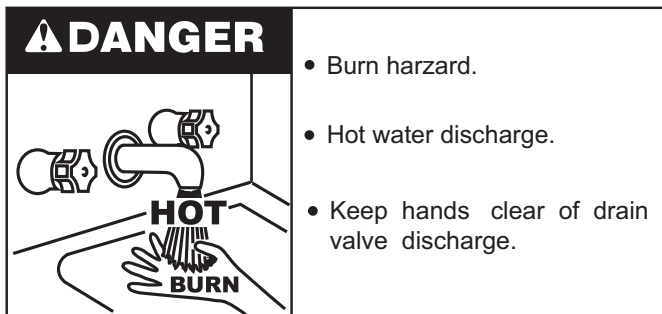

TO DRAIN THE WATER HEATER STORAGE TANK:

1. Turn off the gas supply at the Main Gas Shutoff Valve if the water heater is going to be shut down for an extended period.
2. Ensure the cold water inlet valve is open.
3. Open a nearby hot water faucet and let the water run until the water is no longer hot.
4. Close the cold water inlet valve to the water heater.
5. Connect a hose to the water heater drain valve and terminate it to an adequate drain.
6. Open the water heater drain valve and allow all the water to drain from the storage tank.
7. Close the water heater drain valve when all water in the storage tank has drained.
8. Close the hot water faucet opened in Step 4.
9. If the water heater is going to be shut down for an extended period, the drain valve should be left open.

TO FLUSH THE WATER HEATER STORAGE TANK:

1. Ensure the cold water inlet valve is open.
2. Open a nearby hot water faucet and let the water run until the water is no longer hot. Then close the hot water faucet.
3. Connect a hose to the drain valve and terminate it to an adequate drain.
4. Ensure the drain hose is secured before and during the entire flushing procedure. Flushing is performed with system water pressure applied to the water heater.
5. Open the water heater drain valve to flush the storage tank.
6. Flush the water heater storage tank to remove sediment and allow the water to flow until it runs clean.
7. Close the water heater drain valve when flushing is completed.
8. Remove the drain hose.
9. Fill the water heater - see **Filling the Water Heater** (page 15) .
10. Turn on the gas supply to the water heater at the Main Gas Shutoff Valve.
11. Allow the water heater to complete several heating cycles to ensure it is operating properly.

LEAKAGE TEST POINTS

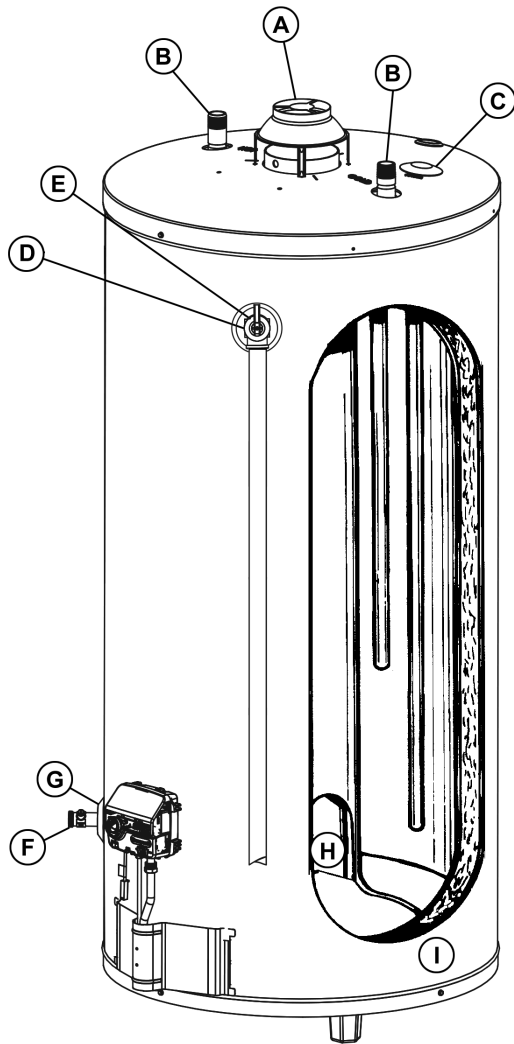



FIGURE 25. WATER HEATER COMPONENTS

- A. Water at the draft hood is water vapor which has condensed out of the combustion products. This is caused by a problem in the vent. Contact the gas utility.
- B. *Condensation may be seen on pipes in humid weather or pipe connections may be leaking.
- C. *The anode rod fitting may be leaking.
- D. Small amounts of water from temperature-pressure relief valve may be due to thermal expansion or high water pressure in your area.
- E. *The temperature-pressure relief valve may be leaking at the tank fitting.
- F. Water from a drain valve may be due to the valve being slightly opened.
- G. *The drain valve may be leaking at the tank fitting.
- H. Combustion products contain water vapor which can condense on the cooler surfaces of the tank. Droplets form and drip onto the burner or run on the floor. This is common at the time of start-up after installation and when incoming water is cold.
- I. Water in the water heater bottom or on the floor may be from condensation, loose connections, or the relief valve. DO NOT replace the water heater until a full inspection of all possible water sources is made and necessary corrective steps taken.

*To check where threaded portion enters tank, insert cotton swab between jacket opening and fitting. If cotton is wet, follow the instructions in *Draining and Flushing* (page 30) and then remove fitting. Put pipe dope or teflon tape on the threads and replace. Then follow the instructions in *Filling the Water Heater* (page 15).



⚠ WARNING

Read and understand instruction manual and safety messages before installing, operating or servicing this water heater.

Failure to follow instructions and safety messages could result in death or serious injury.

Instruction manual must remain with water heater.

SERVICE

Before calling for repair service, read the “Start Up Conditions” and “Operational Conditions” found in the “For Your Information” section of this manual.

If a condition persists or you are uncertain about the operation of the water heater contact a service agency. If you are not thoroughly familiar with gas codes, your water heater, and safety practices, contact your gas supplier or qualified installer to check the water heater.

Use the “Leakage Checkpoints” guide to check a “leaking”

water heater. Many suspected leaks are not leaking tanks. Often the source of the water can be found and corrected.

Read this manual first. Then before checking the water heater make sure the gas supply has been turned OFF, and never turn the gas ON before the tank is completely full of water.

Never use this water heater unless it is completely filled with water. To prevent damage to the tank, the tank must be filled with water. Water must flow from the hot water faucet before turning "ON" gas to the water heater.

Read this manual first. Then before checking the water heater make sure the gas supply has been turned "OFF", and never turn the gas "ON" before the tank is completely full of water.

Never use this water heater unless it is completely filled with water. To prevent damage to the tank, the tank must be filled with water. Water must flow from the hot water faucet before turning "ON" gas to the water heater.

Leakage from other appliances, water lines, or ground seepage should also be checked.

REMOVING AND REPLACING THE GAS CONTROL VALVE/THERMOSTAT

IMPORTANT: This water heater has a resettable thermal switch installed. Do not attempt to disable or modify this feature in any way. Use only factory authorized replacement parts. **IMPORTANT: This gas control valve/thermostat is shipped from the factory as a natural gas unit. However, it may be converted to use LP gas. Before installing this gas control valve/thermostat, make sure that it is configured for the type of gas that you are using.**

REMOVING THE GAS CONTROL VALVE/THERMOSTAT:

1. Turn the gas control/temperature knob to the OFF position. See **Figure 20** (page 24).
2. Turn off the gas at the manual shut-off valve on the gas supply pipe.
3. Drain the water heater. Follow the instructions in **Draining and Flushing** (page 30).

4. Disconnect the igniter wire from the igniter lead wire. Use needle nose pliers to disconnect the red (+) and white (-) thermopile wires. Disconnect the pilot tube (7/16" wrench) and manifold tube (3/4" wrench) at the gas control valve/thermostat. See **Figure 23** (page 32).

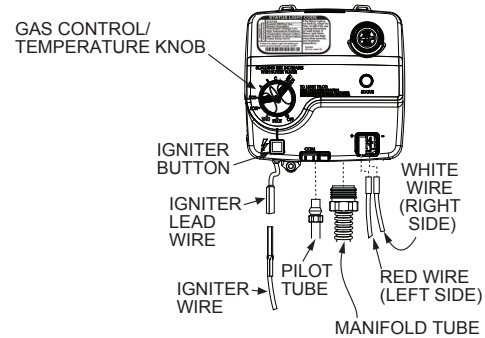

FIGURE 23. GAS CONTROL VALVE REMOVAL

5. Referring to **Figure 24** (page 32), disconnect the ground joint union in the gas piping.
6. Disconnect the remaining pipe from the gas control valve/thermostat.

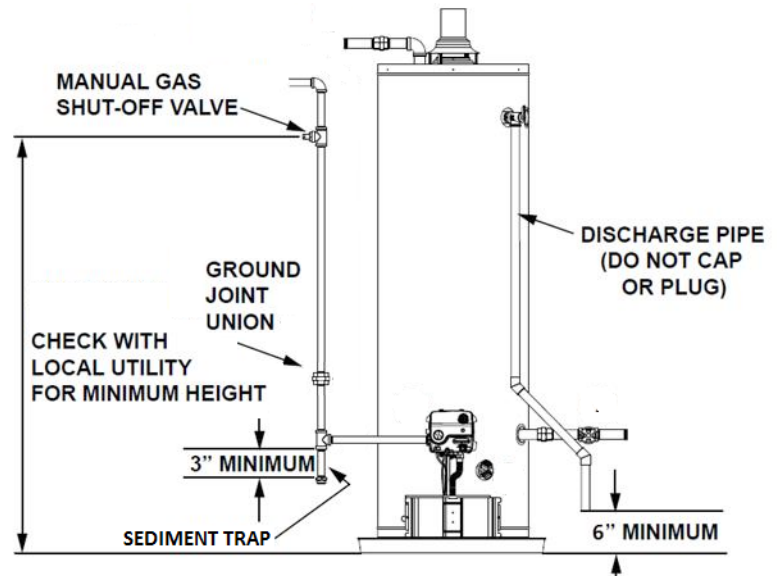

FIGURE 24. PIPING CONFIGURATION

7. To remove the gas control valve/thermostat, thread a 4" section of gas pipe into the gas inlet and use it to turn the gas control valve/thermostat (counterclockwise.) Do not use a pipe wrench or equivalent to grip body. Damage may result, causing leaks. Do not insert any sharp objects into the inlet or outlet connections. Damage to the gas control valve/thermostat may result.

REPLACING THE GAS CONTROL VALVE/THERMOSTAT:

1. To replace the gas control valve/thermostat, reassemble in reverse order. When replacing the gas control valve/thermostat, thread a 4" section of gas pipe into the inlet and use it to turn the gas control valve/thermostat (clockwise). DO NOT OVER TIGHTEN; damage may result.
2. Be sure to use approved Teflon® tape or pipe joint compound on the gas piping connections and fitting on the back of the gas control valve that screws into the tank.
3. Be sure to remove the pilot ferrule nut from the new gas control valve/thermostat.
4. Turn the main gas supply on and check the gas supply connections for leaks. Correct any leak found. Next, light the pilot and main burner, then check the manifold tube and pilot tube connections for leaks. Correct any leak found. Use an approved noncorrosive leak detection solution. If such a solution is not available, use a mixture of hand dish washing soap and water (one part soap to 15 parts water) or childrens' soap bubble solution. Bubbles forming indicate a leak.

Be sure tank is completely filled with water before lighting and activating the water heater. Follow the **Lighting Instructions** on the front of the water heater.

TEFLON® is a registered trademark of E.I. Du Pont De Nemours and Company

TABLE 5. STATUS LIGHT AND DIAGNOSTIC CODE TROUBLESHOOTING CHART

LED Status	Problem	Corrective Action
0 FLASHES (LED NOT LIT)	Pilot light is not lit or Thermopile has not yet reached normal operating temperature.	<p>Turn Gas Control Valve/Thermostat knob to OFF. Wait 10 minutes, then attempt to relight Pilot by following the lighting instructions on the water heater's label. Until the Thermopile reaches its normal operating temperature, the Status Light will not blink, even if the Pilot is lit. It may take up to 90 seconds of continuous Pilot operation before the Thermopile reaches normal operating temperature and the Status Light starts to blink.</p> <p>If the Status Light does not blink after three lighting attempts, check to make sure unit is getting gas. Remove the outer door. Press reset button. Replace outer door. Turn Gas Control Valve/Thermostat knob to OFF. Wait 10 minutes, then attempt to light Pilot by following the lighting instructions on the water heater's label. Look through the view port for the Pilot flame. If Pilot is not visible, the spark igniter or gas supply to the Pilot should be checked.</p> <p>If the Pilot is visible and the Status Light does not blink after 90 seconds of continuous Pilot operation, the Pilot flame may not be heating the Thermopile sufficiently (weak Pilot), the Thermopile may be defective, or wiring connectors may be loose.</p> <p>NOTE: If the water heater has been operating but has stopped and will not re-light, check the flame-arrestor for signs of high temperature (blue or black) discoloration indicating a flammable vapor incident. If you suspect a flammable vapor incident has occurred, do not use this appliance. Immediately call a qualified technician to inspect the appliance. Water heaters subjected to a flammable vapors ignition will require replacement of the entire water heater.</p>
LIGHT ON (SOLID)	Pilot light was recently extinguished and the Thermopile is cooling down.	<p>Turn Gas Control Valve/Thermostat knob to OFF. Wait 10 minutes for the Thermopile to cool, then attempt to relight Pilot by following the lighting instructions on the water heater's label. NOTE: This gas control valve/thermostat has built-in circuitry that requires waiting 10 minutes between lighting attempts.</p> <p>Until the Thermopile reaches its normal operating temperature, the Status Light will not blink, even if the Pilot is lit. It may take up to 90 seconds of continuous Pilot operation before the Thermopile reaches normal operating temperature and the Status Light starts to blink</p>
1 FLASH (EVERY 3 SECONDS)	Normal Operation	No corrective action necessary.
2 FLASHES	Pilot is lit but the Thermopile is not producing the required output voltage.	Turn Gas Control Valve/Thermostat knob to OFF. The Thermopile is probably defective, but loose wiring connections or a weak Pilot flame can also cause this symptom.
4 FLASHES	The Gas Control Valve's temperature sensor has detected that the water temperature was too high. Once this condition occurs, the Main Burner and the Pilot Light will be shut off. Since the Pilot light will be off, should this condition occur, this Flash Code will only be displayed immediately after the Pilot has been relit. Turn Gas Control Valve/Thermostat knob to OFF.	Relight pilot and verify 4 flashes. If 4 flashes are observed, turn Gas Control Valve/Thermostat knob to OFF. Turn Main Gas Supply OFF. Replace the Gas Control Valve/Thermostat. See Removing and Replacing the Gas Control Valve/Thermostat (page 32).

TABLE 5. STATUS LIGHT AND DIAGNOSTIC CODE TROUBLESHOOTING CHART

LED Status	Problem	Corrective Action
5 FLASHES	The temperature sensor (thermistor) is defective.	Turn Gas Control Valve/Thermostat knob to OFF. Turn Main Gas Supply OFF. Replace the Gas Control Valve/Thermostat. See <i>Removing and Replacing the Gas Control Valve/Thermostat</i> (page 32).
7 FLASHES	Gas Control Valve failure.	Turn Gas Control Valve/Thermostat knob to OFF. Turn Main Gas Supply OFF. Replace the Gas Control Valve/Thermostat. See <i>Removing and Replacing the Gas Control Valve/Thermostat</i> (page 32).
8 FLASHES	This condition only appears if the gas control/temperature knob has been turned off and the thermopile continued to produce electric power. This condition can occur if the thermopile does not cool down as quickly as expected when the unit is shut off. This condition can also occur if the gas control/temperature knob has been turned off and the pilot continues to operate because the pilot valve is stuck in the open position.	<p>Make sure that the gas control valve/thermostat knob is set to OFF. Wait one minute. Remove the outer door. Look through the sight glass for a pilot flame. If a pilot flame is observed with the gas control valve/thermostat knob set to the OFF position, the pilot valve is stuck open. Turn the main gas supply OFF. Replace the gas control valve/thermostat. For instructions, see <i>Removing and Replacing the Gas Control Valve/Thermostat</i> (page 32).</p> <p>If the pilot flame is not observed when the gas control valve/thermostat knob is set to the OFF position, wait 10 minutes for the thermopile to cool, then attempt to relight the pilot by following the lighting instructions on the water heater's label. If this condition returns, replace the gas control valve/thermostat. See <i>Removing and Replacing the Gas Control Valve/Thermostat</i> (page 32).</p>

TABLE 6. GENERAL TROUBLESHOOTING GUIDELINES

These guidelines should be used by a qualified service agent.

Symptom	Problem	Corrective Action
WATER LEAKS	Improperly sealed, hot or cold supply connection, relief valve, drain valve, or thermostat threads.	Tighten threaded connections.
	Leakage from other appliances or water lines.	Inspect other appliances near water heater.
	Condensation of flue products.	See Condensation (page 25).
LEAKING T&P VALVE	Thermal expansion in closed water system.	Install thermal expansion tank (DO NOT plug T&P valve).
	Improperly seated valve.	Check relief valve for proper operation (DO NOT plug T&P valve).
SMELLY WATER	High sulfate or mineral content in water supply.	Drain and flush heater thoroughly, then refill.
	Bacteria in water supply.	Chlorinate or aerate water supply.
PILOT WILL NOT LIGHT	Gas control knob not positioned correctly.	See the Lighting Instructions on the water heater's label.
	Main gas supply off.	Turn on main gas shutoff valve.
	Thermopile malfunction.	Replace pilot/thermopile assembly.
	No spark.	Locate piezo switch on thermostat. Replace if needed.
BURNER WILL NOT STAY LIT	Thermopile malfunction.	Replace pilot/thermopile assembly.
	Defective Gas Control.	Replace Gas Control.
PILOT OUTAGE	Dirty pilot burner.	Clean pilot assembly.
	Thermopile malfunction.	Replace pilot/thermopile assembly.
	Defective Gas Control.	Replace Gas Control.
	Thermopile tip is not in contact with pilot flame.	Insert thermopile correctly.
NOT ENOUGH HOT WATER	Heater not lit or thermostat not on.	See Lighting Instructions on the water heater's label.
	Thermostat set too low.	See Temperature Regulation (page 24).
	Heater undersized.	Reduce hot water use.
	Low gas pressure.	Contact your gas supplier.
	Incoming water is unusually cold.	Allow more time for heater to re-heat.
	Leaking hot water pipes or fixtures.	Have plumber check and repair leaks.
	High temperature limit switch activated.	Contact a service agency to determine cause.
WATER TOO HOT	Thermostat set too high.	See Temperature Regulation (page 24).
WATER HEATER SOUNDS	Condensation dripping on burner.	See Condensation (page 25).
SIZZLING OR RUMBLING	Sediment or calcium in bottom of heater tank.	Drain and flush the water heater. See Draining and Flushing (page 30).
SOOTING	Improper combustion.	No adjustment available. Contact a service agency to determine cause.
VENT GAS ODORS	Lack of supply air.	Contact a service agency to determine cause.
	Improperly installed vent piping.	
	Downdraft.	
	Poor combustion.	

